

ANNUAL REPORT OF THE COLLEGIUM MEDITERRANISTARUM
MEDITERRANEUS XX
—OFFPRINT—

A Preliminary Report of the General Survey
at Dahshur North, Egypt

S. YOSHIMURA/J. KONDO/S. HASEGAWA/T. SAKATA/M. ETAYA/
T. NAKAGAWA/S. NISHIMOTO

COLLEGIUM MEDITERRANISTARUM (CHICHUKAIGAKKAI) 1997
Head Office : S. Nagao, Musashino Art University, Tokyo
Secretariat : Ogawa Bldg. 201, Funamachi II, Shinjuku-ku, Tokyo, 160 Japan
Telephone 03-3350-1228/FAX 03-3350-1229

A Preliminary Report of the General Survey at Dahshur North, Egypt

S. Yoshimura/ J. Kondo/ S. Hasegawa/ T. Sakata/
M. Etaya/ T. Nakagawa/ S. Nishimoto

INTRODUCTION

Recently we received new topographical informations on the Memphite area and we had to reconsider its historical framework. The Nile has changed its flow 3km eastward since the dynastic period and not only Memphite civil town “*Ankh-Tawy*” also, its necropolis formation could be determined by reconstructions of the dynastic waterfront with the funeral complex.

Here trial methods were intended to be used in Egyptology. Research and Information Center of Tokai University began to analyze satellite data from the ecological point of view and then the Egyptian Culture Center of Waseda University commenced field observations from the archaeological point of view in the area from Abusir to Danshur.

Consequently, the area between Kendjer’s (13th Dynasty) and Senwosret’s (12th Dynasty) cemeteries was most noteworthy (Fig.1), as we found that the hilltop, situated 1km west of this point, had stable limestone bedrock with the height of 47-50m similar to the two cemeteries.

We call this area “Dahshur North,” because it is located between the military railway of Dahshur and Snefru’s Red Pyramid. The area is indicated on Lepsius’s map (Fig.2), but nothing was reported about the ruins.⁽¹⁾ E.A.O.’s (Egyptian Antiquities Organization) research in the 1970s and 1980s seemed not to have been conducted beyond south of the military railway, namely the Kendjer’s area,⁽²⁾ while recent expeditions into the precinct of the Senwosret’s pyramid were made by the Metropolitan Museum of Art.⁽³⁾

For these reasons, nobody has mentioned this area scientifically so far, but as the control of the area was transferred from the military office to the S.C.A.’s (Supreme Council of Antiquities), the first attempt became possible. Then we carried out the

general survey from March 4 to 31, 1996, and we found the site to be a cemetery composed of the mud brick building, possibly the New Kingdom tomb chapel with the largest example of Horemheb at Saqqara and shafts around it. It will be a new topography of the Memphite necropolis.

We would like to express our thanks to S.C.A.'s messieurs, in particular to his excellency, the previous secretary general, Dr. Abd al-Halim Nur al-Din, and general director of S.C.A., pharaonic section, Dr. Aly Hasan (now secretary general of S.C.A.). As for the areal control, we also thank Dr. Zahi Hawass, the general director of the Giza inspectorate, Mr. Muhammad Hagra, the general director of the Saqqara inspectorate, Mr. Magdy al-Ghandur and Mr. Khalid Abu Laila, inspectors of the Saqqara inspectorate.

(YOSHIMURA Sakuji, Director of The Egyptian Culture Center, Waseda University
 SAKATA Toshibumi, Director of Research and Information Center, Tokai University
 NAKAGAWA Takeshi, Professor, The Department of Architecture, Waseda University)

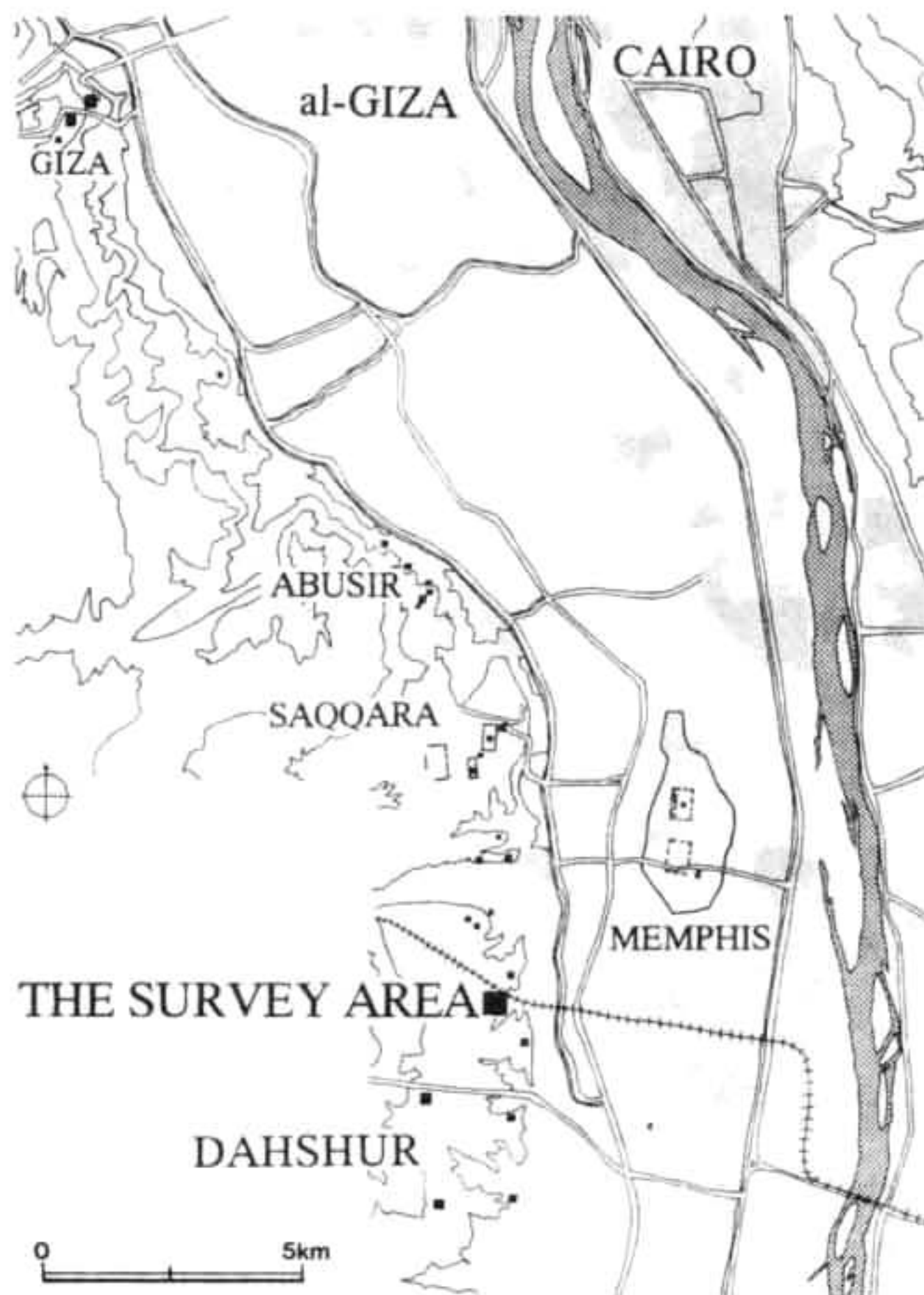

Fig. 1 The Memphite Necropolis Location Map

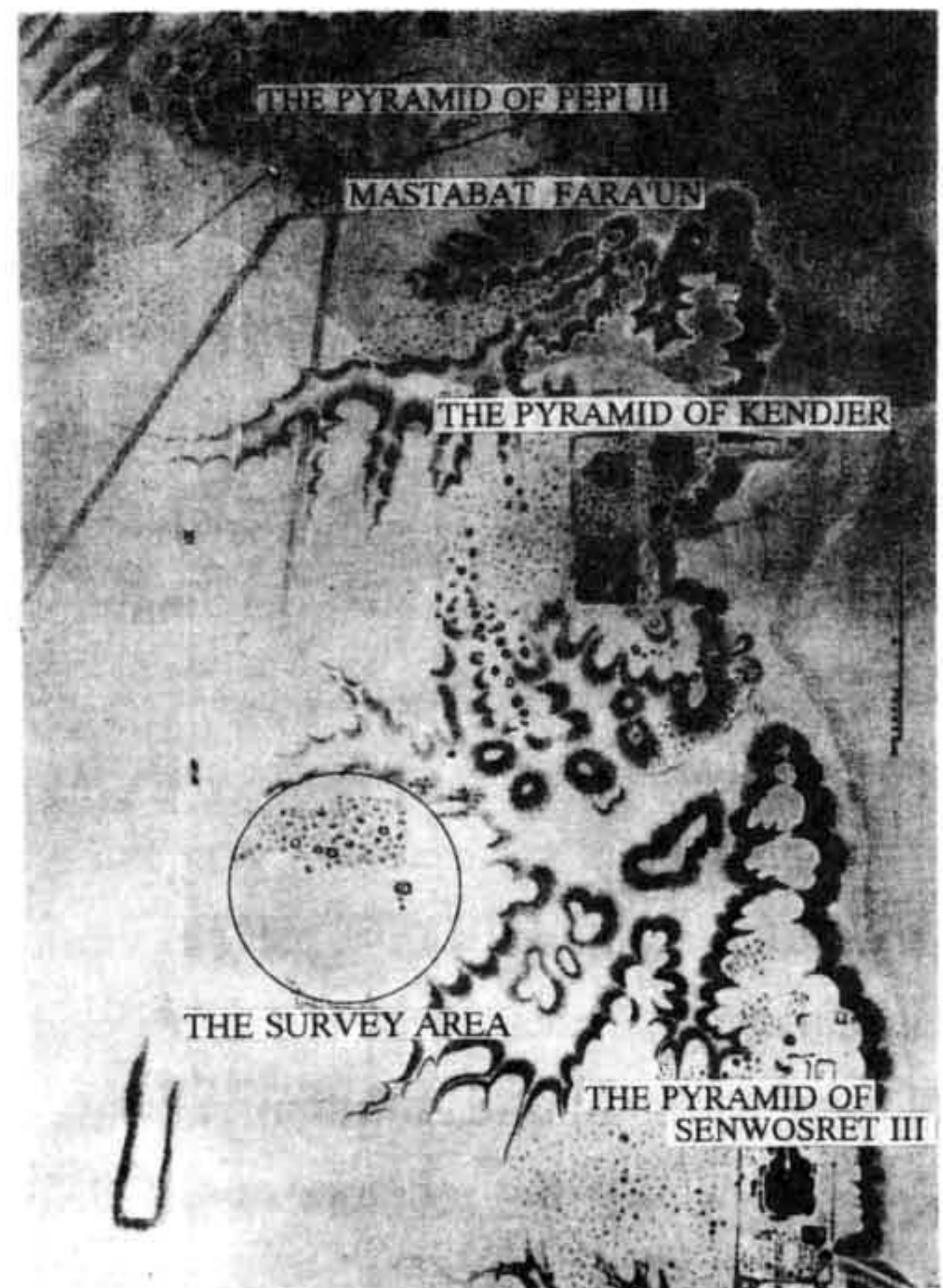

Fig. 2 The Location Map of the Area (after C.R. Lepsius, *Denkmaeler aus Aegypten und Aethiopien*, Band I, Berlin 1852)

I: METHODS OF THE SURVEY

1: Introduction

The joint project of Tokai University and Waseda University was authorized for the studies. Technical method of the remote sensing is explained, and then, methods and the outline of the general survey is described. Further, results of ecological and archaeological studies will be expected in the future at the site of Dahshur North.

2: Satellite remote sensing technology

1) Analysis of the data

Satellite remote sensing technology can be a powerful tool for a wide range observation in the field of archaeological study with the advantage of high resolution sensors represented by the French earth observation satellite SPOT-HRV. In addition, Synthetic Apertur Radar (SAR) data of the Japanese Earth Resources Satellite JERS-1 and the European Remote Sensing Satellite EERS-1, which observes the surface characteristics of the earth, roughness and gradients, is expected as a new tool for the archaeological observation.

SAR data of JERS-1 and EERS-1, and optical data of the American earth observation satellites LANDSAT-TM, SPOT-HRV and the Russian 2m resolution satellite data KVR-1000 covering the observation area were collected for this study (Pl.1). To begin with, SAR data of JERS-1 and EERS-1 were analyzed to find a cemetery's bedrock, limestone or mud brick remains, and pottery sherds scattered on the desert. Next, high resolution optical images of SPOT-HRV, LANDSAT-TM and KVR-1000 were intensively analyzed to find the shapes and other characteristics of existing remains seen from satellites, especially focusing on some collapsed pyramid bases, ranging from Abu Rawash to Mazghuna.

2) 3-D simulation

Furthermore, Digital Elevation Model (DEM) of the same area was made by utilizing topographic maps in the scale of 1: 5,000, because ecological analysis is also important. In antiquity, it is considered that there was an annual inundation which covered most of the land in the Nile valley. The water level fluctuation model of the Nile in antiquity was reproduced by 3-D simulation with the aid of the DEM data. As a consequence of the simulation, we concluded that almost all pyramids and major remains are located on a bedrock higher than 40 meters above sea level which was not flooded in the dynastic period.

Based on the satellite analysis and 3-D simulation, 38 observation targets were

extracted for our study. The targets were overlaid with satellite images and geographical maps, and the results were printed as a field map scaled 1 : 10,000.

3) Surface observation

Repeated surface observations were carried out for checking the target sites on the field maps with the spots. In the process of surface observation, there were some significant findings that some of the extracted targets were obviously ancient sites which have not been reported yet, though most of them were inside other's concession area.

Consequently the area of Dahshur North was found important for the study of the necropolis formation in the Memphite area, as the area is located on stable limestone bedrock and it is surrounded by the Old and the Middle Kingdom monuments.

3 : Archaeological research

1) Grid system

The site was measured 700m square (Pl.2) and standard measurement point L was set at the southwestern corner of the area. We divided this area by 7 every 100m square from west to east (1-7), and from south to north (A-G), totaling 49 major grids. Each major grid was divided into 10m grids, for a total 100 minor grids (Fig.3). As for the cleaning research point, 5m square was most available, and the grids were divided into four 5m squares, named from "a" to "d". The central hilltop was measured 100m (NS)×300m (EW), and here more than 150 surface deposits, in which 15 shafts were found disturbed already, were described on it (Fig.4).

2) Expansion of the cemetery

The shafts are described later and the next discussion was on the expansion of the cemetery. We chose three points, where the distribution of the limestone chips were dense on the surface. We sought these points by the underground research using an electromagnetic wave,⁽⁴⁾ and then cleaned these points. At two points (4D-26b and 4B-82d), remains were not found and gravel was found 10-30cm under the surface. The only exception was the western point (3E-21a), where a part of shaft entrance and its side construction were found. The cemetery seemed to expand on the Grid 2E-4E, though further extension could be westward beyond Grid 2E.

3) Shafts

A total of 15 shafts were found disturbed already (Pl.3). Most of them had the entrance of the shaft with the scale ca.2m long and 1m wide, and the direction of the axis was approximately on a NS line. As for the superstructure, we could not find any traces in this season. At the shaft entrance, the slabs (No.14) or mud bricks

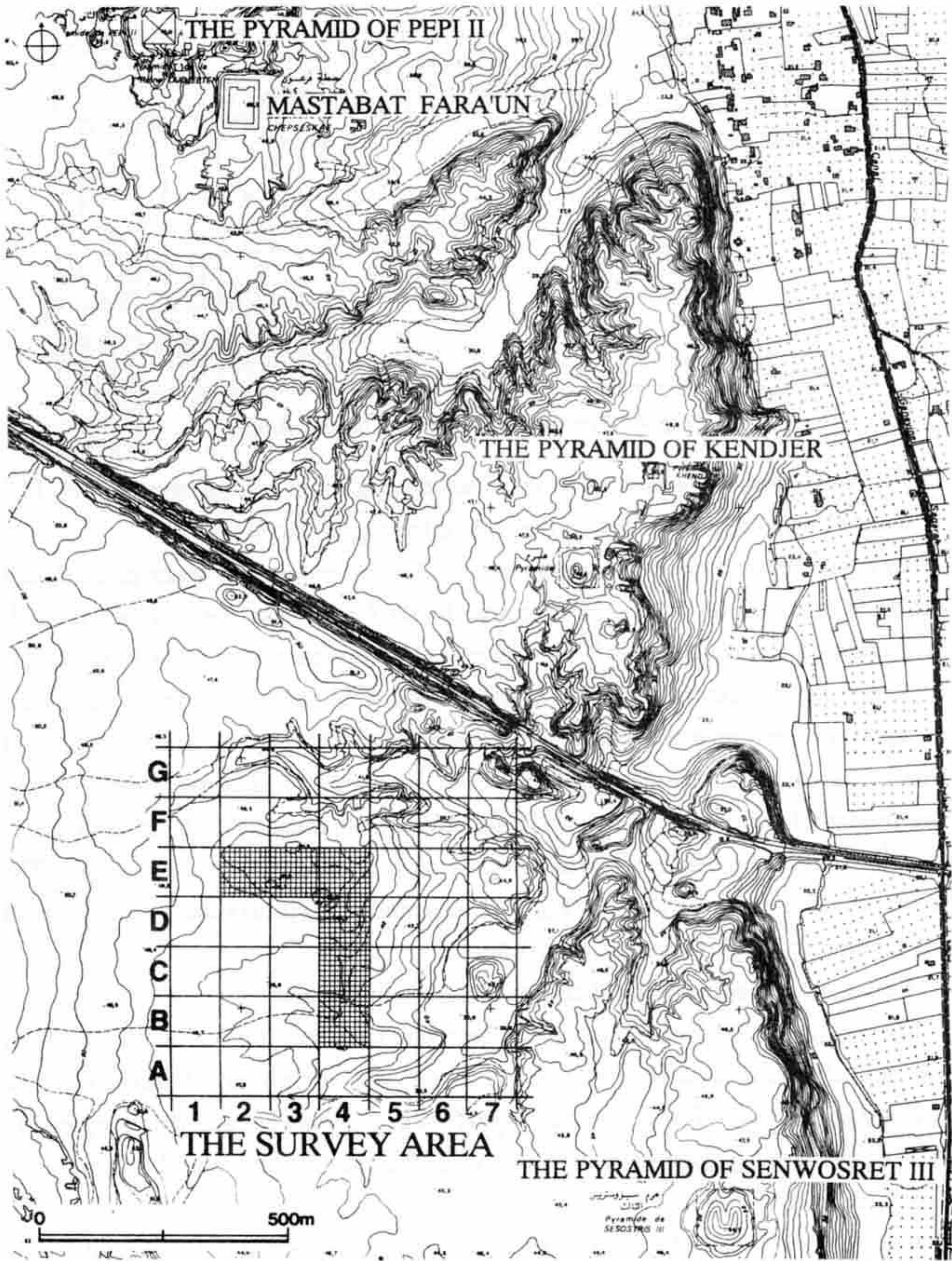

Fig. 3 The Location Map of the Area

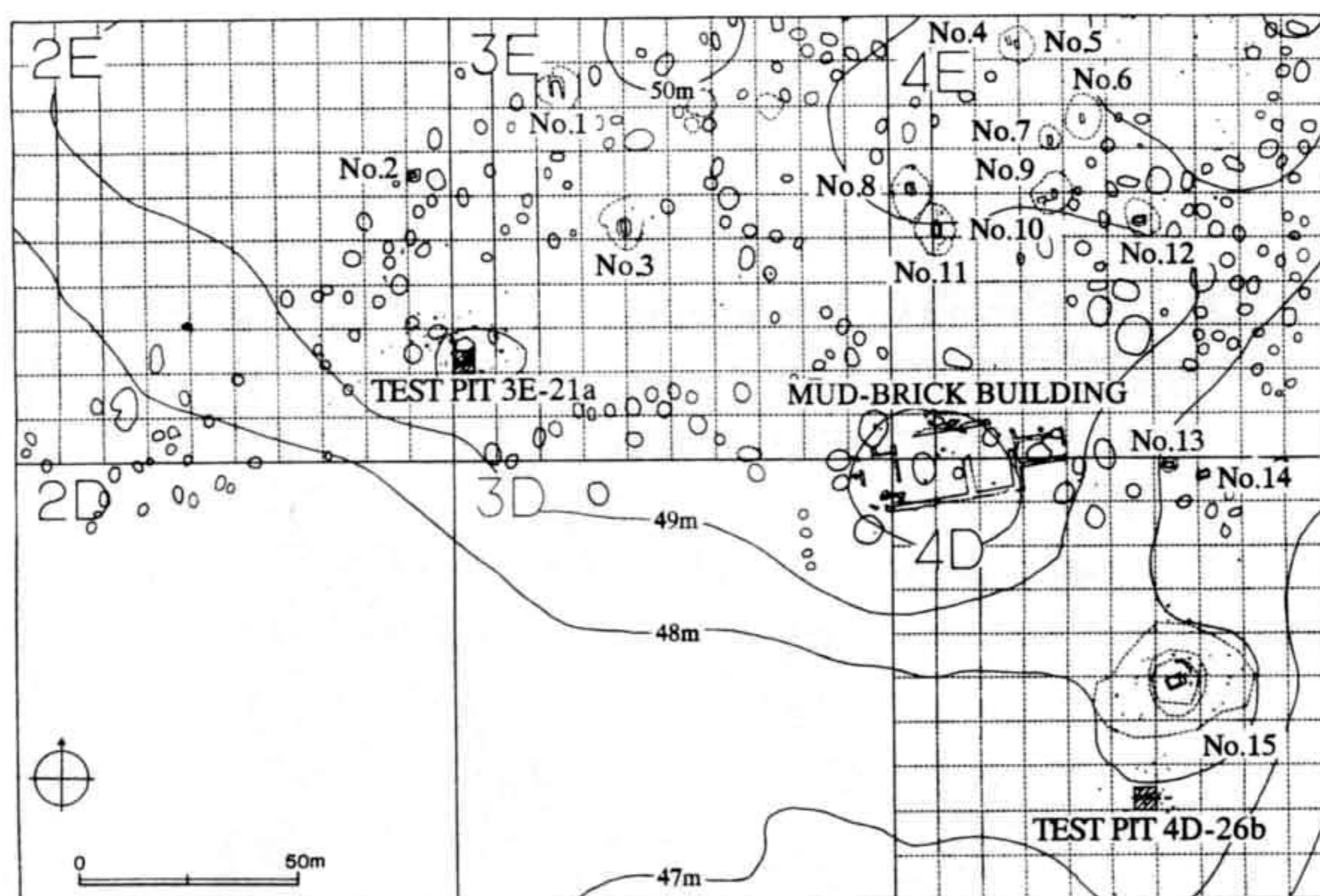

Fig. 4 The Central Part of the Survey Area

(No.11) were used, and sometimes the bricks were covered with plaster (No.13) (Pl.5, 1). Toe holds could be observed on the wall of the shafts (No.8) (Pl.5, 2).

Since sand deposits covered shafts, we could observe only two inner plans (Nos.8, 14). In both cases, the inner chamber was found 7-8m under the entrance (Pl.5, 3), measuring ca. 5m square, and it was supported by a rectangular pillar in the center (Pl.5, 4).⁽⁵⁾ Rough sketch plan is shown (Fig.5) and sand deposit lied thickly and fragments of a limestone sarcophagus, pottery sherds, and bones were scattered (Pl.5, 5). The burial chamber was measured ca. 2.5-4m long and 1.2-1.6m wide. Here a dense distribution of the pottery sherds and mud bricks were found (Pl.5, 6). In both shafts, no wall decoration or epigraph was found by surface observation in this season. The largest shaft in the area (No.15) (Fig.6) is indicated on Lepsius's map, but the detail will be reported after the future excavation.

4 : Ecological and archaeological studies in the Memphite area

The ecology of the dynastic Egypt has been discussed, but the necropolis formation was not referred to from the ecological point in the Memphite area.⁽⁶⁾ From the area at Dahshur North, a New Kingdom cemetery will be revealed, and it is supposed to be near the possible ancient waterfront, where the necropolis could be approached from Memphis.

(ETAYA Masahiro, Section of Remote Sensing and Ecological Studies
HASEGAWA So, Section of Archaeology)

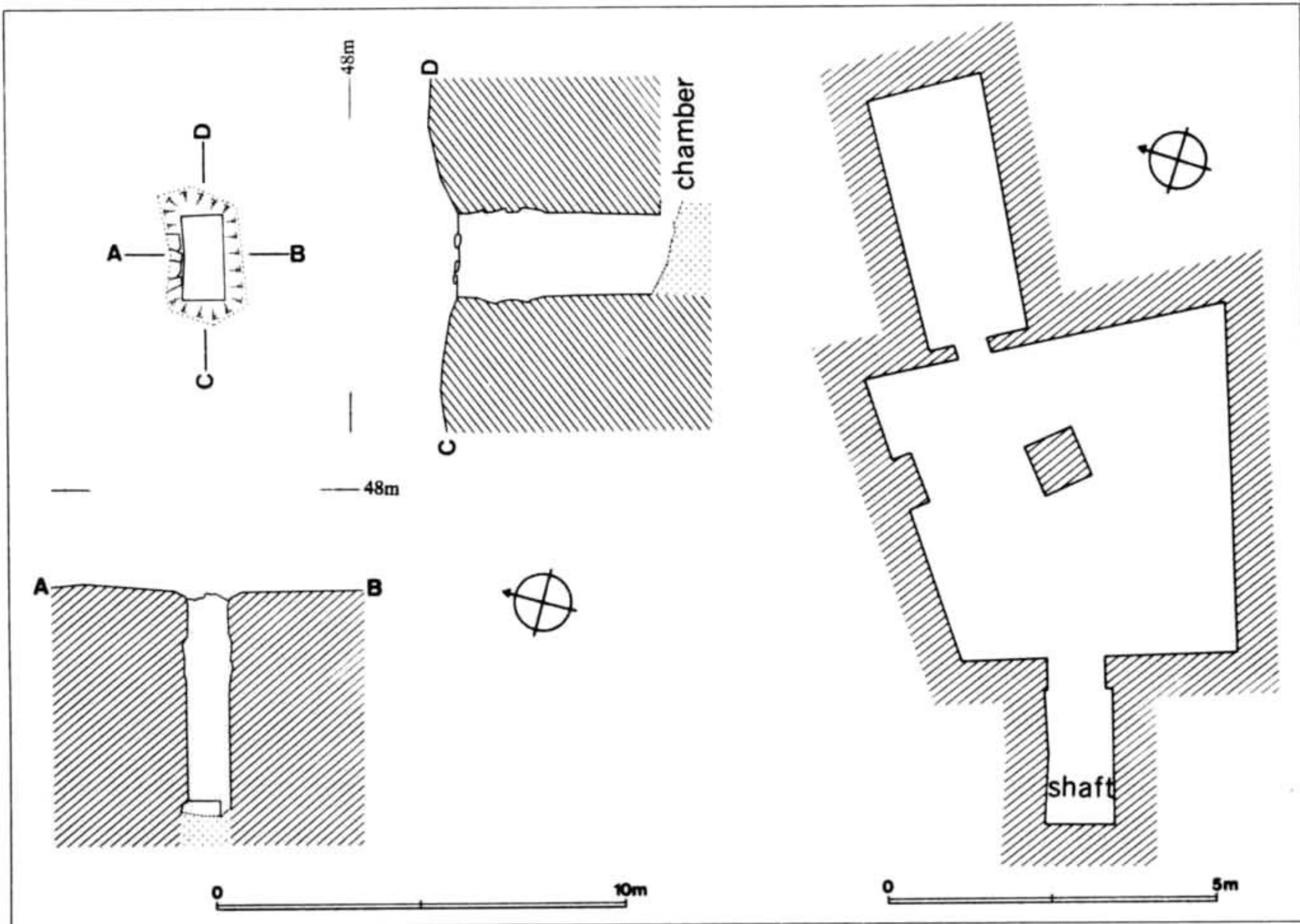

Fig. 5 The Plan and Sections of Shaft No. 14

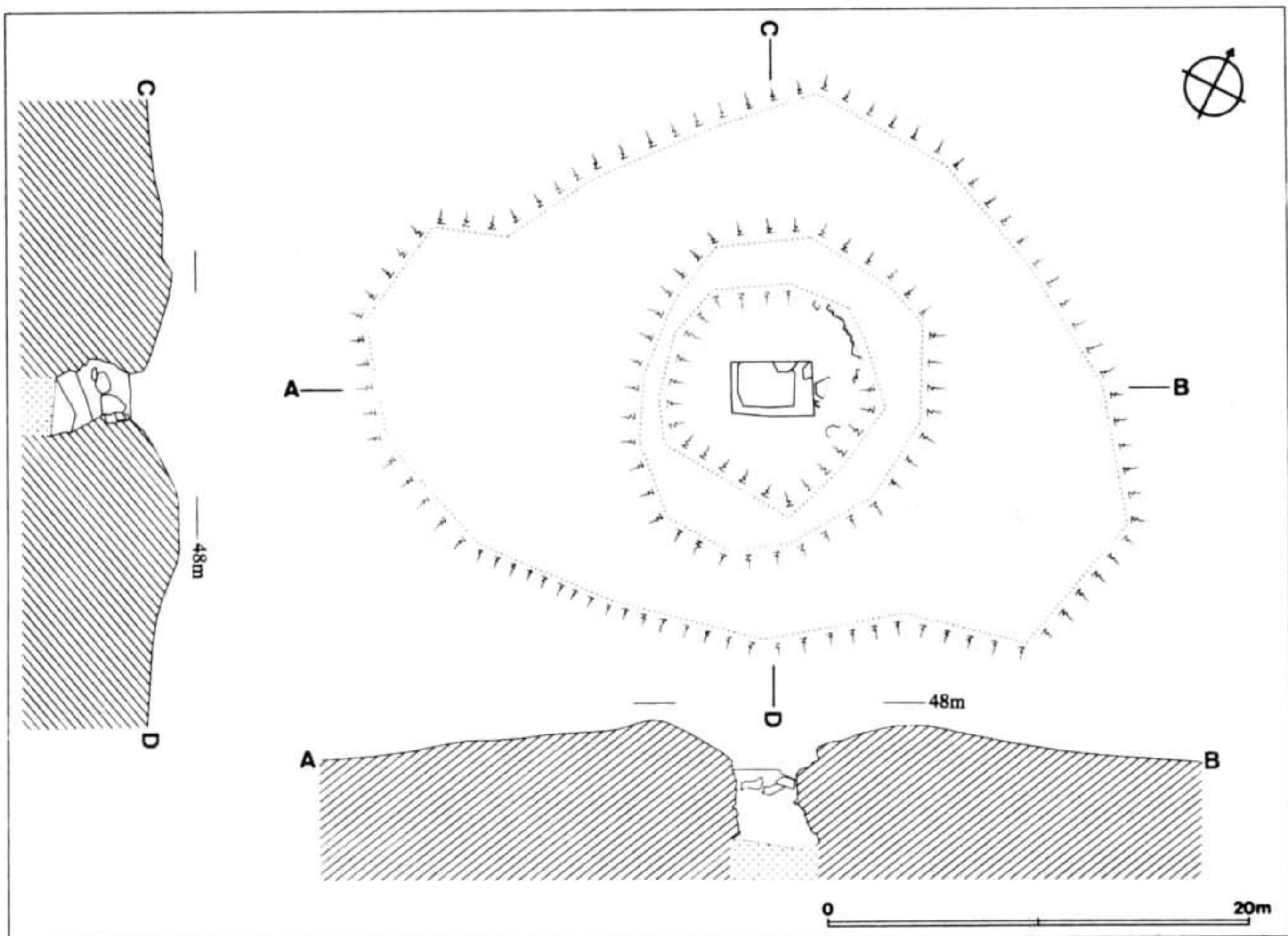

Fig. 6 The Plan and Sections of Shaft No. 15

II : FINDS

1 : Introduction

We recovered a number of fragments of various objects during the course of the clearance of the area. In this preliminary report, only part of the finds will be reported in detail.

2 : The description of the finds

1) A fragment of sealing (Fig.7, 1, Pl.6, 2) :

An oval shaped seal is stamped lightly on the surface of mortar. The seal impression is incomplete but we can see a crouching animal that seems to be Anubis or Seth on the upper part that we have retrieved.⁽⁷⁾

2) Fragments of stone blocks with reliefs and inscriptions :

Several stone fragments have been recovered from the area. Most of them are limestone. The inscriptions are not complete because they are mostly very small fragments (Pl.6, 1). We may see the Wedjet eye on two fragments (Fig.7, 2/3). The fragment in Fig.7, 4 shows the inscription khenty ...

3) Fragments of painted pottery (Fig.7, 5/6, Pl.6, 5) :

A great number of pottery fragments have been collected from the surface of the excavation area. Among them blue painted ones are characteristic of the fragments uncovered in this area.⁽⁸⁾⁽⁹⁾

4) A fragment of an ostrakon with a picture of a man's head (Fig.7, 7, Pl.6, 4) :

The picture is drawn inside a fragment with black ink. It shows part of a man's head with his ear. Judging from the way the ear is drawn, this ostrakon seems to belong to the Ramesside period. We can see some similarity with the style of ostrakon painting of the Ramesside examples.⁽¹⁰⁾

5) A fragment of pottery with incised marks (Fig.7, 8, Pl.6, 3) :

6) A fragment of a blue glass vessel (Fig.7, 9, Pl.6, 7) :

It seems to be a part of the bottom of a goblet. The date unknown.

7) Fragments of stone vessels (Fig.7, 10/11) :

We recovered two fragments from two different stone vessels. One is made of diorite and the other is made of alabaster (Pl.6, 6). Both of them are parts of the mouths of jars. It is not possible to decide the dates of the vessels from the styles.

8) Amulets (Fig.7, 12/15) :

1. A Bes shaped amulet made of light blue faience (Pl.6, 9). Judging from its shape, it seems to belong to the New Kingdom.⁽¹¹⁾

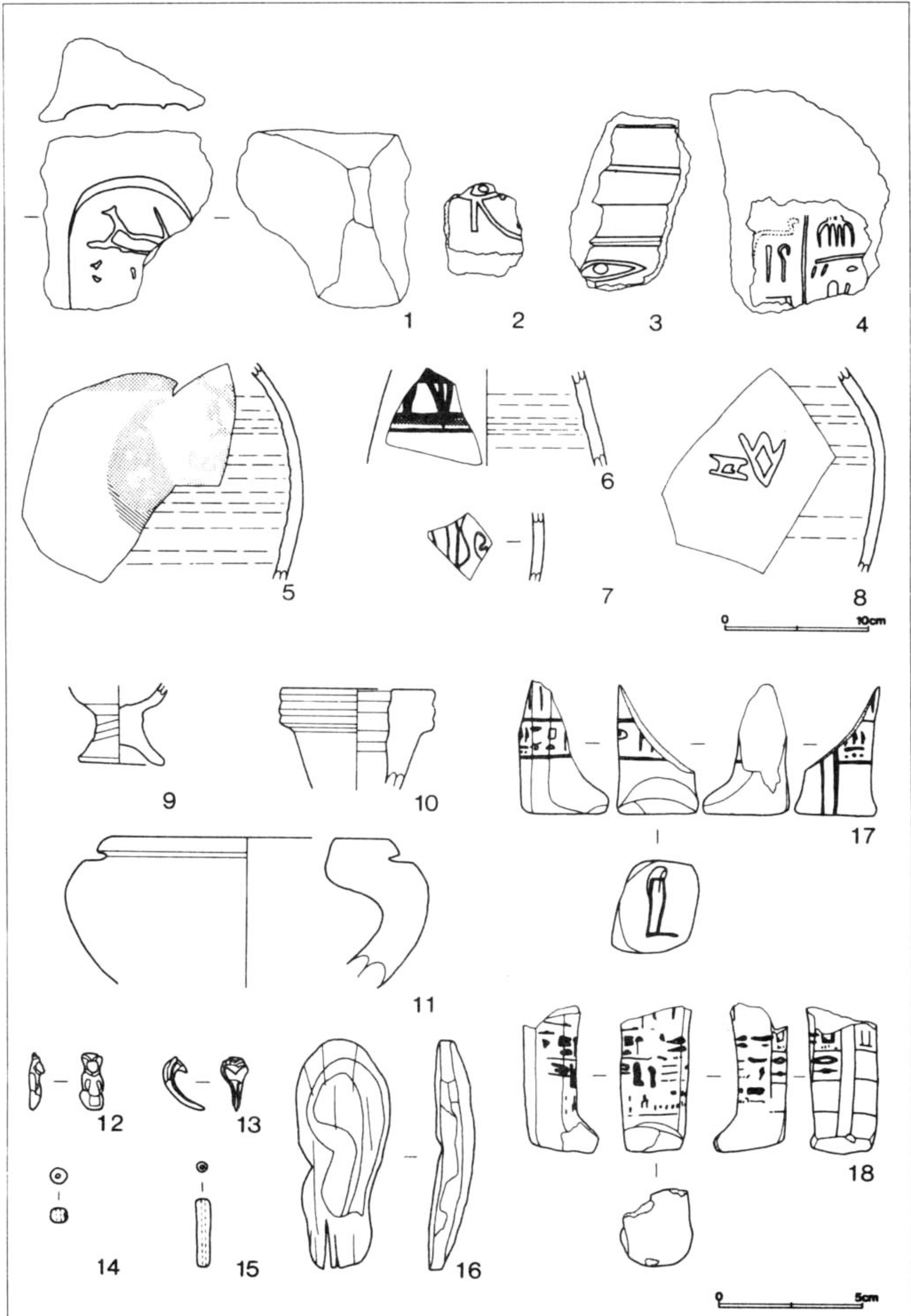

Fig. 7 Selected Finds

2. A bronze Urae(?) fragment.
3. A glass bead. Dark blue glass is inlaid within yellow glass.
4. Faience bead.
- 9) A wooden model ear (Fig.7, 16, Pl.6, 8) :
- 10) Fragments of faience shabti figures (Fig.7, 17/18, Pl.6, 10) :

We recovered two fragments of shabtis. They are the feet of two blue faience shabtis. They are inscribed with the shabti formula from the Book of the Dead. On the bottom surface of one of them a human figure is drawn in black ink.⁽¹²⁾ Judging from their styles, I believe that these shabtis belong to the late 18th Dynasty or the early 19th Dynasty.⁽¹³⁾

3 : Summary

By observing the finds from this survey area, we may narrow down the date of the site as that between the late 18th Dynasty to the Ramesside period in the New Kingdom. Particularly, the shabtis from the area show characteristic features of the beginning of the 19th Dynasty when we compare them with the examples shown in the study by Hans Schneider.

(KONDO Jiro, Section of Egyptology)

III : A BRICK ARCHITECTURE OF THE NEW KINGDOM⁽¹⁴⁾

1 : Introduction

In the course of clearance work undertaken after a preliminary surface reconnaissance in this season, a brick structure of considerable size was articulated at the site (Pl.4). The building is situated on a hill top that marks the center of the excavation area at Dahshur, and commanding a view of several pyramids located nearby and the Memphite area. Due to the disappearance of the wall to the level of foundations, no traces of doorways have been found so far. Only a few courses of mud bricks seems to be preserved.

2 : Present state of the building

After measurement was carried out, preliminary plans and sections were created by surveyors at the site. Fig.8 is a simplified plan drawn by the author indicating the remains of walls observed on the ground. The walls A1 and A2 running in parallel have been much weathered and eroded on the inward sides, while the outward sides are preserved in fairly good condition (Pl.7, 1). The two parallel walls B1 and B2, running almost the length of this building, cross thick walls C (Pl.7, 2) and D, as well as much damaged walls F1-3 and I (Pl.7, 4), forming rooms E and G respectively. The

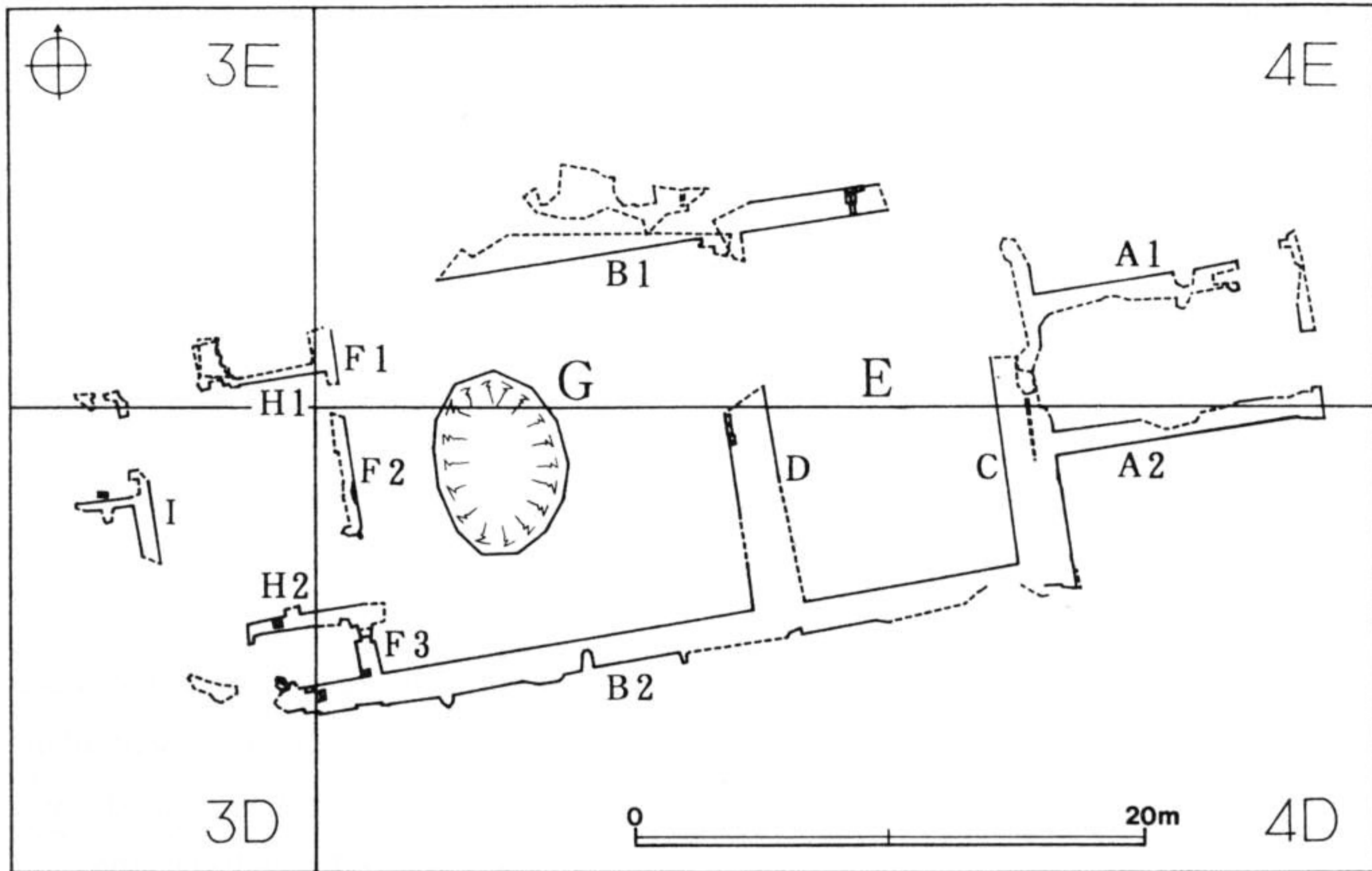

Fig. 8 The Plan of the Mud-brick Building

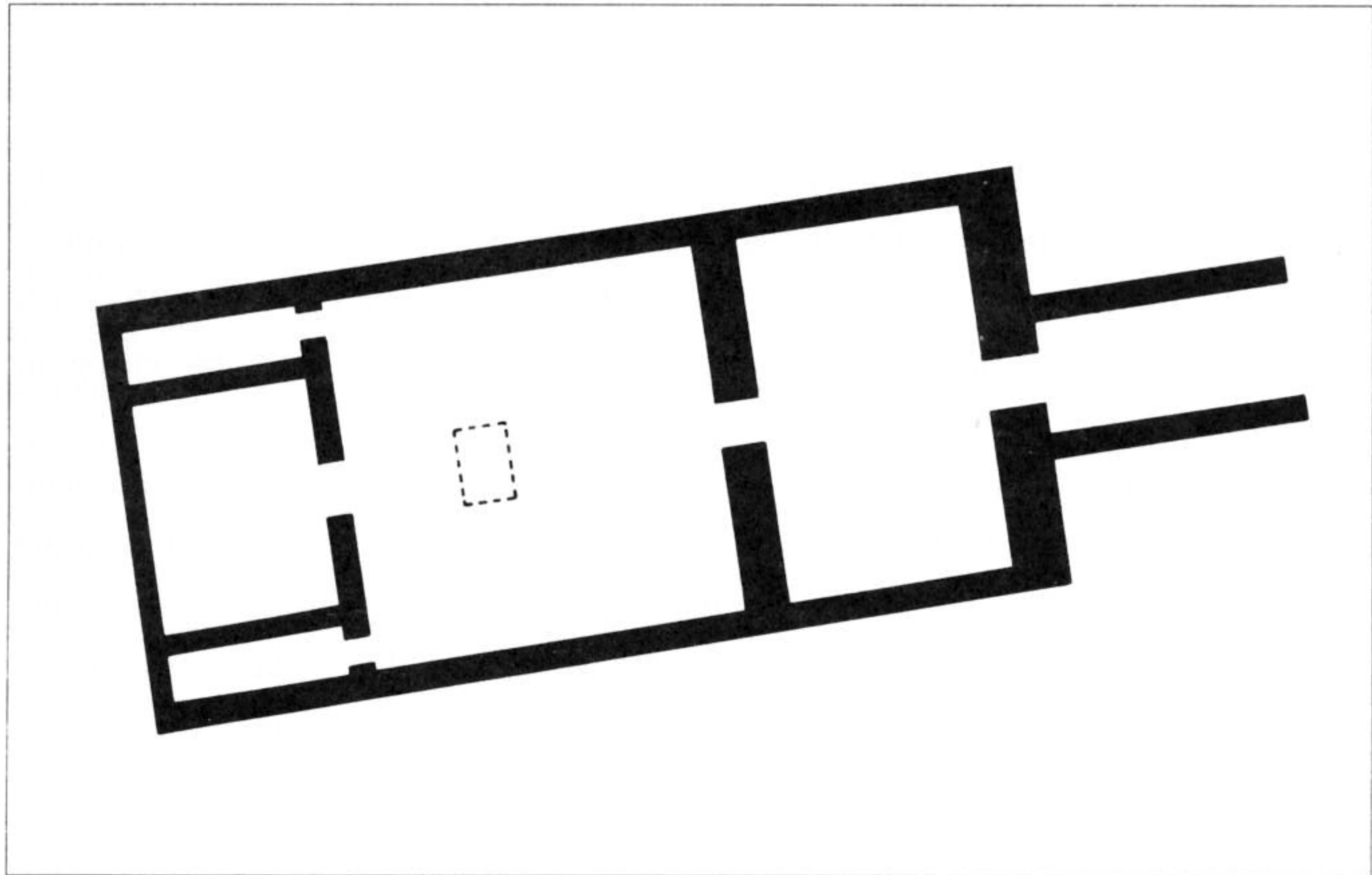

Fig. 9 Tentative Reconstruction of the Mud-brick Building by Nishimoto

floor level of room E is elevated approximately 1m from that of the area flanked by the walls A1 and A2 (Pl.7, 3). The room G seems to be deliberately designed as square in plan. Its floor level is again elevated slightly from that of room E, and a large depression is visible as shown in Fig.1 (Pl.7, 5). It should be noted that the dense scatters of limestone chips have been observed on both floors of rooms E and G, suggesting the use of stone blocks such as column bases or pavement slabs in the building.

The average dimensions of bricks is ca.36cm×18cm×9cm. Although only one stamped brick was found, the inscriptions in the rectangular sealing had been badly damaged and is illegible (Pl.7, 6). The size of the stamped rectangular impression on the brick is 63mm in width, 110mm in height.

3 : Discussion

In spite of rather inadequate information provided from the ruins, one of the most prominent architectural features seems to be evidently an axially arranged plan, roughly aligned to east-west. Presumably the parallel walls A1 and A2 would have formed an access corridor⁽¹⁵⁾ being approached from the east, and it is likely that the outward sides have been banked by desert sand and thus protected from weathering and deterioration. On the other hand, the plan with the rectangular enclosure clearly indicates the typical architectural elements of the Egyptian temple plan.⁽¹⁶⁾ Particularly the remarkable point is the tripartite sanctuaries situated at the rear to the westernmost part preceded by transverse and square open courts (Fig.9). The great depression in room G could be considered to be a vertical shaft leading to a burial chamber in the underground.

As described elsewhere in this report, the sherds belonging to the late 18th Dynasty or the early 19th Dynasty have been scattered around the building. Two fragments of blue-glazed shabtis found nearby would be also dated to the same period.⁽¹⁷⁾ The brick building in question is thus strongly suggested to correspond to the tomb chapel of the New Kingdom,⁽¹⁸⁾ based on its plan and several finds.

It should be noted that one of the largest tomb chapels has been found at Dahshur. The total length would be approximately 47m if the access corridor is included, and the width is up to about 17m. There are no parallels except perhaps for that of Hor-emheb at Saqqara, ca.47m in length and 15m in width,⁽¹⁹⁾ or that of Maya and Meryt at the same site (45m in length⁽²⁰⁾). The walls of both tombs are built of mud brick with limestone revetment, and it is generally accepted that this construction method was executed in the tomb chapels after the transfer of the capital from Amarna to Memphis by Tut'ankhamun until the first half of the reign of Ramesses II.⁽²¹⁾ The

brick building recently found at Dahshur might have also been originally cased with limestone externally.

4 : Conclusion

Although the activity of the first season was strictly limited, it is clear that the large scale tomb chapel exists here at Dahshur as well as Saqqara, Thebes, Gurob and Abydos. In order to clarify the function and form of this building, it is hoped to conduct further detailed investigation.

(NISHIMOTO Shin-ichi, Section of Architecture)

CONCLUSION

A new method of remote sensing was used on the Memphite necropolis studies, and the site of Dahshur North was found to be important for the necropolis formation and ecological studies of the Memphite area. The central area is a cemetery on the stable limestone bedrock compared with the neighboring pyramid cemetery, which is composed of the shafts around the central mud brick building. The plan of the mud brick building reminded us of a New Kingdom tomb chapel found at Saqqara, and the best comparative example was the tomb chapel of Horemheb. In our case, the owner's name and his king was unknown yet, although one stamped mud brick was found, which was too damaged to be read.

Anyhow the finds recovered from the surface indicate the same datation, and it will be a new important discovery to reconsider the Memphite necropolis from Saqqara to Dahshur area. As in the case of Saqqara, the New Kingdom cemeteries are formed on the hilltop at the south of Unas's causeway⁽²²⁾ and at the east of Teti's pyramid.⁽²³⁾ Both of them are constructed near their predecessor's monument, and their parts, such as a causeway or valley temple were re-used, possibly as an approach from Memphis to the necropolis.⁽²⁴⁾

The New Kingdom monuments have not been reported in Dahshur so far, and the site is on a high location between the area of south Saqqara and Dahshur. The area is surrounded by the Old Kingdom and the Middle Kingdom monuments, and its topographical importance will be revealed with the next excavation.

(YOSHIMURA Sakuji, KONDO Jiro, HASEGAWA So)

Abbreviations

ASAÉ	<i>Annales du Service des Antiquités de l'Égypte</i>
BIÉ	<i>Bulletin de l'Institut Égyptien</i>
CCÉ	<i>Cahiers de la Céramique Égyptienne</i>
JEA	<i>The Journal of Egyptian Archaeology</i>
MDAIK	<i>Mitteilungen des Deutschen Archäologischen Instituts abteilung Kairo</i>
Or	<i>Orientalia</i>
RE	<i>Revue d'Égyptologie</i>
SAK	<i>Studien zur Altägyptischen Kultur</i>
ZÄS	<i>Zeitschrift für Ägyptische Sprache und Altertumskunde</i>

NOTES

- (1) C.R. Lepsius, *Denkmaeler aus Aegypten und Aethiopien*, Berlin 1885, Abth. I, Bl.35, Text I, 208, and he mentioned nothing except pyramids and their area. Barsanti or Borchardt sought Dahshur area generally, but they did not refer to the area. See A. Barsanti, "Rapport sur la fouille de Dahchour," *ASAÉ*, 3(1902), 198-205; L. Borchardt, "Ein Königserlaß aus Dahschur," *ZÄS*, 42(1905), 1-11.
Snefru's Red Pyramid is located 1km south of the area, and researches were limited in the pyramid's complex. See, A. Fakhry, *The Monuments of Sneferu at Dahshur*, 2 vols., Cairo, 1959-61, or "The excavation of Snefru's monuments at Dahshur. Second preliminary report," *ASAÉ*, 52(1954), 563-594; Recent German mission's excavations were also in its complex. See R. Stadelmann, "Die Pyramiden des Snofru in Dahschur, Erster Berichte über die Ausgrabungen an der nördlichen Steinpyramide," *MDAIK*, 38(1982), 379-393, and the reports of the same titles in *MDAIK*, 39(1983), 225-241; *MDAIK*, 49(1993), 259-294.
- (2) Kendjer's area was reported by G. Jéquier, "Rapport préliminaire sur les fouilles exécutées en 1924-1925 dans la partie méridionale de la Nécropole Memphite," *ASAÉ*, 25(1925), 55-75, and recent researches by E.A.O., see A.H. Moussa, "A Stela of Taharqa from the Desert Road at Dahshur," *MDAIK*, 37(1981), 331-337.
- (3) Senwosret III's area was excavated in the late 1900s, see J. de Morgan, *Fouilles à Dahchour*, 2 vols., Vienna 1895 and 1903, and recent Metropolitan Museum's expeditions are concentrated on the pyramid itself and the southern and northern tombs besides the pyramid. See, D. Arnold, and R. Stadelmann, "Dahschur, Erster Grabungsbericht," *MDAIK*, 31(1975), 169-174, and successive season's reports by D. Arnold, in *MDAIK*, 33(1977), 15-20, *MDAIK*, 36(1980), 15-21; and *MDAIK*, 38(1982), 17-23; *Or*, 61(1992), 251; *Or*, 63(1994), 387; *Or*, 64(1995), 264-265.
- (4) The system of the underground research is the same way which Waseda University used in the Giza and Abusir area. See S. Yoshimura, T. Nakagawa, S. Tonouchi and K. Seki, *Studies in Egyptian Culture*, No.6, Non-Destructive Pyramid Investigation (1)—By Electromagnetic Wave Method—, Tokyo 1987, 53-60.
- (5) The plan with the rectangular pillar at the center is rarely found in the neighboring cemeteries, see de Morgan, *op. cit.* and Jéquier, *op. cit.* It can be datable with the cleaning work in future.
- (6) As for the ecology in the prehistoric period, see K.W. Butzer and C.L. Hansen, *Desert and River in Nubia*, London 1968. In the dynastic period, see M.M. el-Gamili and F.F.A. Shaaban "Tracing Buried Channels in Northwestern Dakahlia Governorate, Nile Delta, Using Hammer Seismograph and Electric Resistivity Profiling," in ed. by van den Brink, *The Archaeology of the Nile Delta, Problems and Priorities*, Amsterdam 1988. The Nile from the dynastic to Islamic period according to the historical author's reference, see O. Tousson, *Mémoire sur les Anciennes Branches du Nil*, le Caire 1922.
- (7) On the so-called Necropolis seal, see "The seal of the Necropolis," by O.E. Kaper, in ed. by J. Baines, *Stone vessels, pottery and sealings from the Tomb of Tut'ankhamun*, Oxford 1993,

165ff.

- (8) M. Bell, "Regional Variation in Polychrome Pottery of the 19th Dynasty," *CCÉ*, 1(1987), 6-76.
- (9) C.A. Hope, "Blue-painted and polychrome decorated Pottery from Amarna : A Preliminary Corpus," *CCÉ*, 2(1991), 3-92.
- (10) A. Page, *Ancient Egyptian Figured Ostraca in the Petrie Collection*, Warminster 1983 ; A. Gasse, *Catalogue des Ostraca figurés de Deir el-Médineh Nos.3100-3372* (5^e Fascicule), Le Caire 1986, Nos.3167, 3230.
- (11) B. Schilick-Nolte and V. von Droste zu Hülshoff, *Skarabän, Amulette, und Schmuck, Liebieghaus-Museum alter Plastik, Ägyptische Bildwerke Band I*, Melsungen 1990, 217-226.
- (12) J. Kondo, "A Preliminary Report on the Re-clearance of the Tomb of Amenophis III (WV22)," in ed. by C.N. Reeves, *After Tut'ankhamun*, London 1992, 50.
- (13) H.D. Schneider, *Shabtis, An Introduction to the History of Ancient Egyptian Funerary Statuettes with a Catalogue of the Collection of Shabtis in the National Museum of Antiquities at Leiden*, Part I-III, Leiden 1977.
- (14) This text is a fully revised version of a paper originally presented to the Annual Meeting of the Architectural Institute of Japan (AIJ) in 1996 entitled "A Building of the New Kingdom found at Dahshur-north, 1" in Japanese : cf. S. Nishimoto et al. in *Summaries of Technical Papers of Annual Meeting AIJ 1996*, 391-392, Tokyo. I would like to thank KASHIWAGI Hiroyuki and ENDO Takaharu, my colleagues at the Department of Architecture, for their help and valuable suggestion. I am indebted to Messrs. KAWAI Nozomu and WADA Koichiro, both of the Egyptian Culture Center of Waseda University, for providing useful information on the tomb chapels of the New Kingdom. Thanks are also due to Chris Rollston and KAWAI Nozomu, both of the graduate students of the Johns Hopkins University, for their correcting the English for the text.
- (15) This recalls the "causeway" in the plans of tomb 36 and 37 at Gurob, see G. Brunton and R. Engelbach, *Gurob, British School of Archaeology in Egypt 41*, London 1972, 11: Pl. XIX, A.P. Thomas, *Gurob ; A New Kingdom Town*, Warminster, 1981, 22.
- (16) cf. A. Badawy, *A History of Egyptian Architecture : The Empire*, Berkeley 1968, 176-177.
- (17) Consideration by KONDO Jiro. On the parallels, see H.D. Schneider, *op.cit.*, 95-99, Nos.3.3.0.1; 3.3.0.3; 3.3.1.7; 3.3.1.11.
- (18) See the recent comprehensive discussions, cf. D. Polz, "Dra' Abu el-Naga ; Die thebanische Nekropole des frühen neuen Reiches," in ed. by J. Assmann, E. Dziobek, H. Guksch, F. Kampp, *Thebanische Beamtennekropolen. Studien zur Archäologie und Geschichte Altägyptens 12*, Heidelberg 1995, 25-42 ; D. Raue, "Zum memphitischen Privatgrab im neuen Reich," *MDAIK*, 51(1995), 255-268.
- (19) G.T. Martin, *The Memphite Tomb of Horemheb Commander-in-chief of Tut'ankhamun I*, London 1989, Pl.5.
- (20) G.T. Martin, M.J. Raven, B.G. Aston, and J. van Dijk, "The Tomb of Maya and Meryt ; Preliminary Report on the Saqqara Excavations, 1987-8," *JEA*, 74(1988), Fig.1.
- (21) J. van Dijk, "The Development of the Memphite Necropolis in the Post-Amarna Period," in ed. by A.-P. Zivie, *Memphis et ses nécropoles au Nouvel Empire*, Paris 1988, 42-43 ; G.T. Martin, *The Hidden Tombs of Memphis*, London 1991, 40-41.
- (22) As for the free standing tomb chapels on the hilltop, see G.T. Martin, 1989 and 1991, *op.cit.*; G.T. Martin, et al, *The Tomb-Chapels of Paser and Ra'ia at Saqqara*, London 1985, and its preliminary reports of the excavations, see *JEA* since 1976.
- (23) V. Loret, "Fouilles dans la Nécropole Memphite (1897-1899)," *BIÉ*, 3(1899), 85-100 ; J.E. Quibell, and A.G.K. Hayter, *Teti Pyramid, North Side*, Cairo 1927, 10-11 ; J. Málek, "The Tomb-Chapel of Hekamaetre-neheh at Northern Saqqara," *SAK*, 12(1985), 43-60.
- (24) Approach from Memphis is mentioned. see D.G. Jeffreys, *The Survey of Memphis I*, London 1985. As for the Memphite topography in the New Kingdom, see K.A. Kitchen, "Towards a reconstruction of Ramesside Memphis," in ed. by W.J. Murnane, *Fragments of a Shattered Visage*, Memphis 1991, 87-104 ; D.G. Jeffreys, and H.S. Smith, "Memphis and the Nile in the

エジプト ダハシュール北地区調査報告

吉村作治／近藤二郎／長谷川奏／坂田俊文／恵多谷雅弘／中川 武／西本真一

早稲田大学古代エジプト調査室と東海大学情報技術センターは、エジプトの古都メンフィスとその葬送地域の構造を解明する手がかりとして、近年古環境調査でも応用されている衛星写真の援用を試みた。考古学的手法による遺跡の分布調査を平行して行なった結果、ダハシュール北地区に位置する丘陵頂部が、メンフィス葬送地域の構造概念と王朝時代の古環境研究に新たな知見をもたらすものと期待された。

調査地点は、古王国から第2中間期に至るピラミッド群に囲まれた遺跡環境にある。耕地際には王朝時代の河岸基点を想起させる緑地帯があり、遺跡はここに接した高位の岩盤上にある。当該地区は19世紀の中頃レプシウスが作成した遺跡地図に載るが、遺跡の存在に言及する記述はなく、その後軍事地区に取り入れられたため、科学的な調査は本例が学史の上でも初めてとなろう。700m四方のエリアを占める調査地区の中でも、標高が49～50mと最も高く、東西300m、南北100mにわたる丘陵頂部が遺構の集中分布地点であった。地表面では15基のシャフトが観察されたが、このうち2基は前室が方形の一本柱によって支えられ、最奥部に埋葬室が配された特徴的な構造を有していた。シャフト入り口と推測される凹み面は、地表面に多数見受けられたため、本遺跡は広大な墓域となろう。さらに遺構が集中的に分布する地区には、地表面に土器片や石製容器片などの密な散布がみられ、特にシャブティ像の施文形態からは、新王国時代第19王朝初期という年代的位置付けが推測された。今期調査で最も注目されたのは、丘陵南部より検出された日乾煉瓦遺構である。検出されたプランから、同遺構は新王国時代に特徴的な高官墓 (Tomb Chapel) と推測された。上部構造は失われており、被葬者の名は現段階では不明であるが、遺構規模は長軸47mを測り、サッカラ地区で出土した第18王朝末のホルエムヘブの墳墓に匹敵する。

従来類例の高官墓の報告はサッカラ地区に集中していたため、ダハシュールにおいて新王国時代の墓域が検出されたとなれば初めての例となる。したがって当面は今後の発掘調査によって墓域内のプランが明らかにされていくことが期待されるが、さらには新王国時代の墓域が成立していった歴史的環境が考察対象となり、ナイル川をめぐる古環境の復元考察とあいまって、メンフィス地区の葬送地域像が再構築されていくであろう。

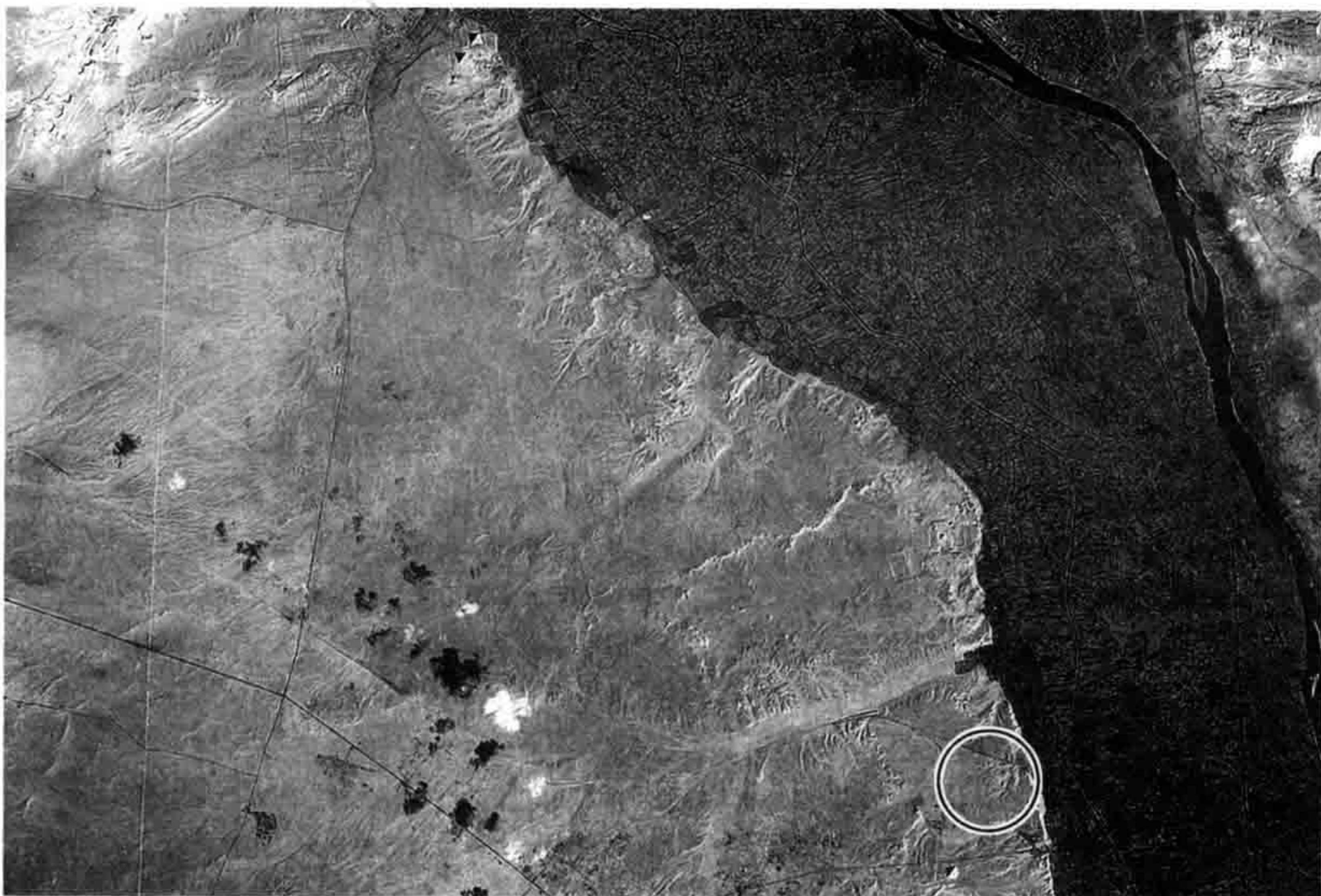

Pl. 1 A Satellite Photograph of the Pyramid Area



Pl. 2 General View of the Survey Area

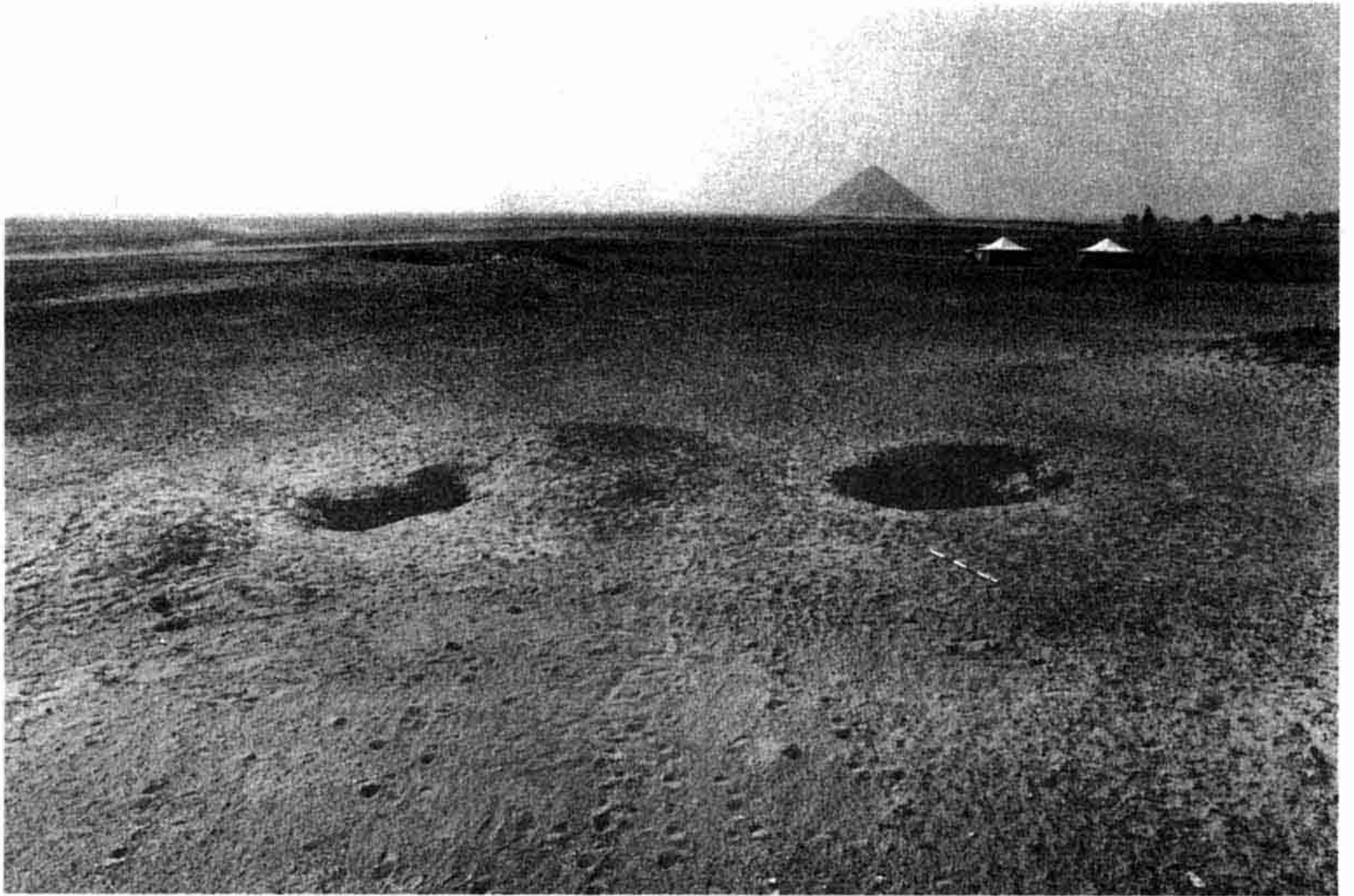

Pl. 3 General View of the Shafts

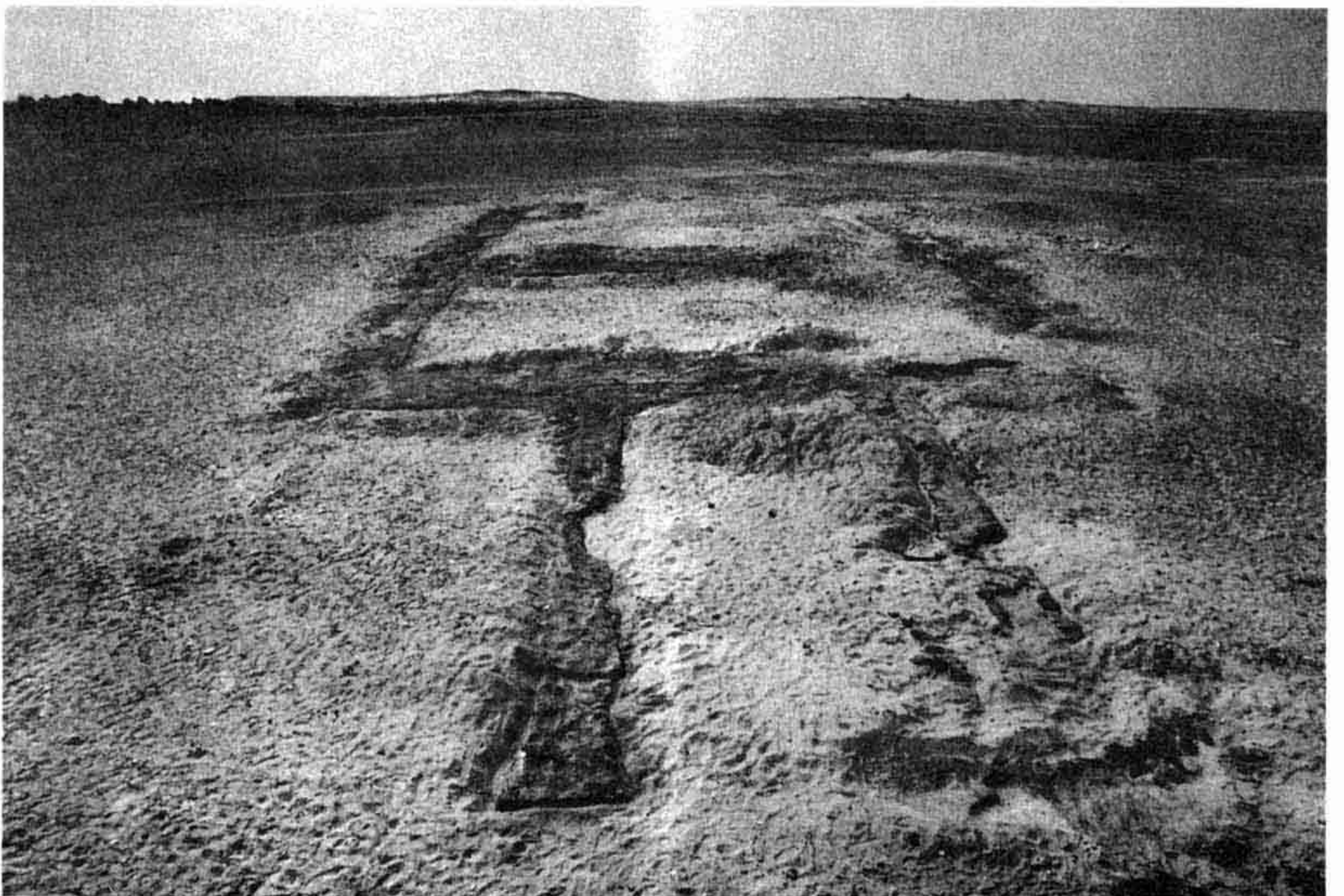

Pl. 4 The Mud-brick Building, from the east



Pl. 5-1 The Shaft No. 13, plastered wall

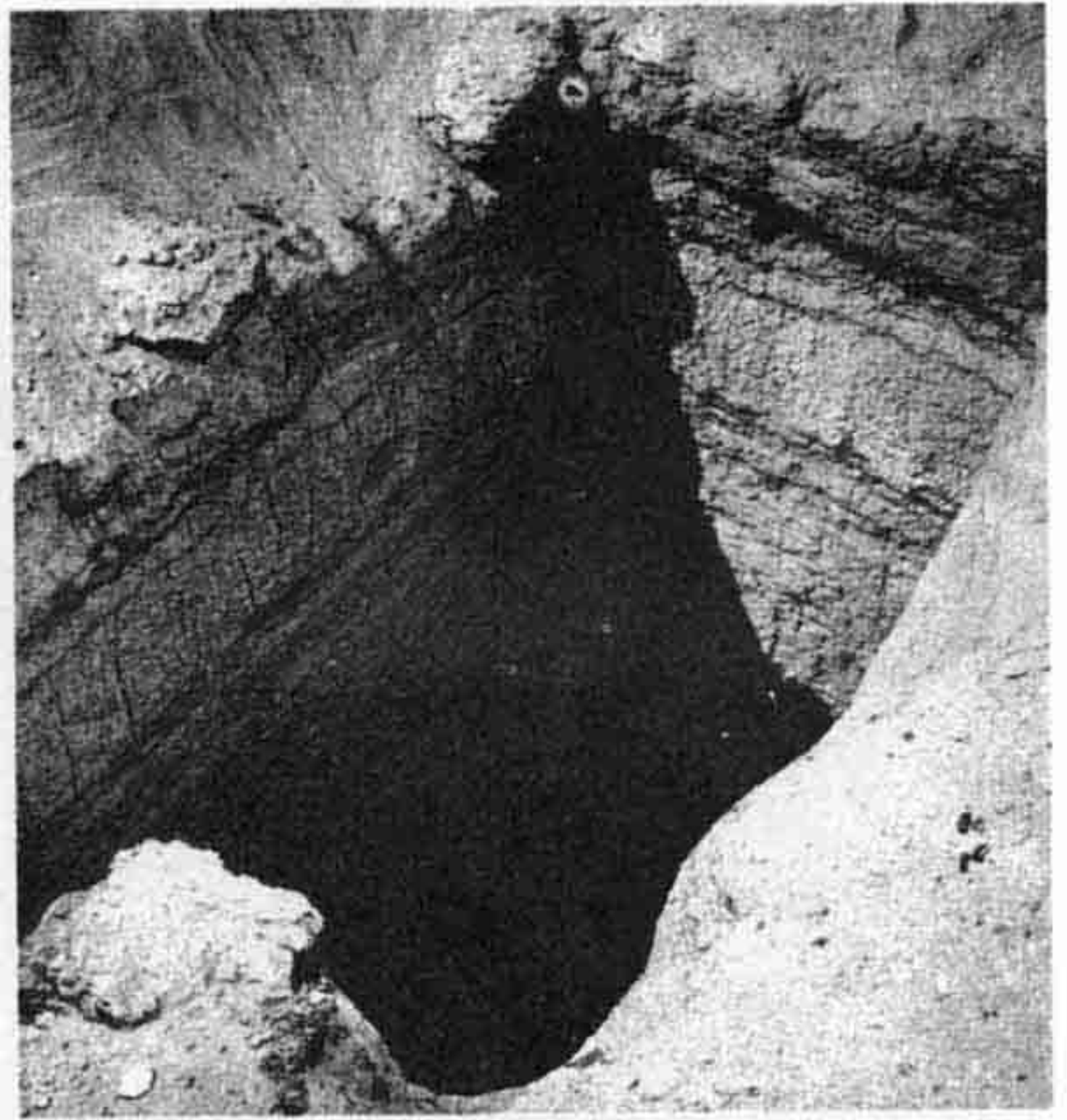

Pl. 5-2 The Shaft No. 8, toe holds



Pl. 5-3 The Entrance of the Inner Chamber

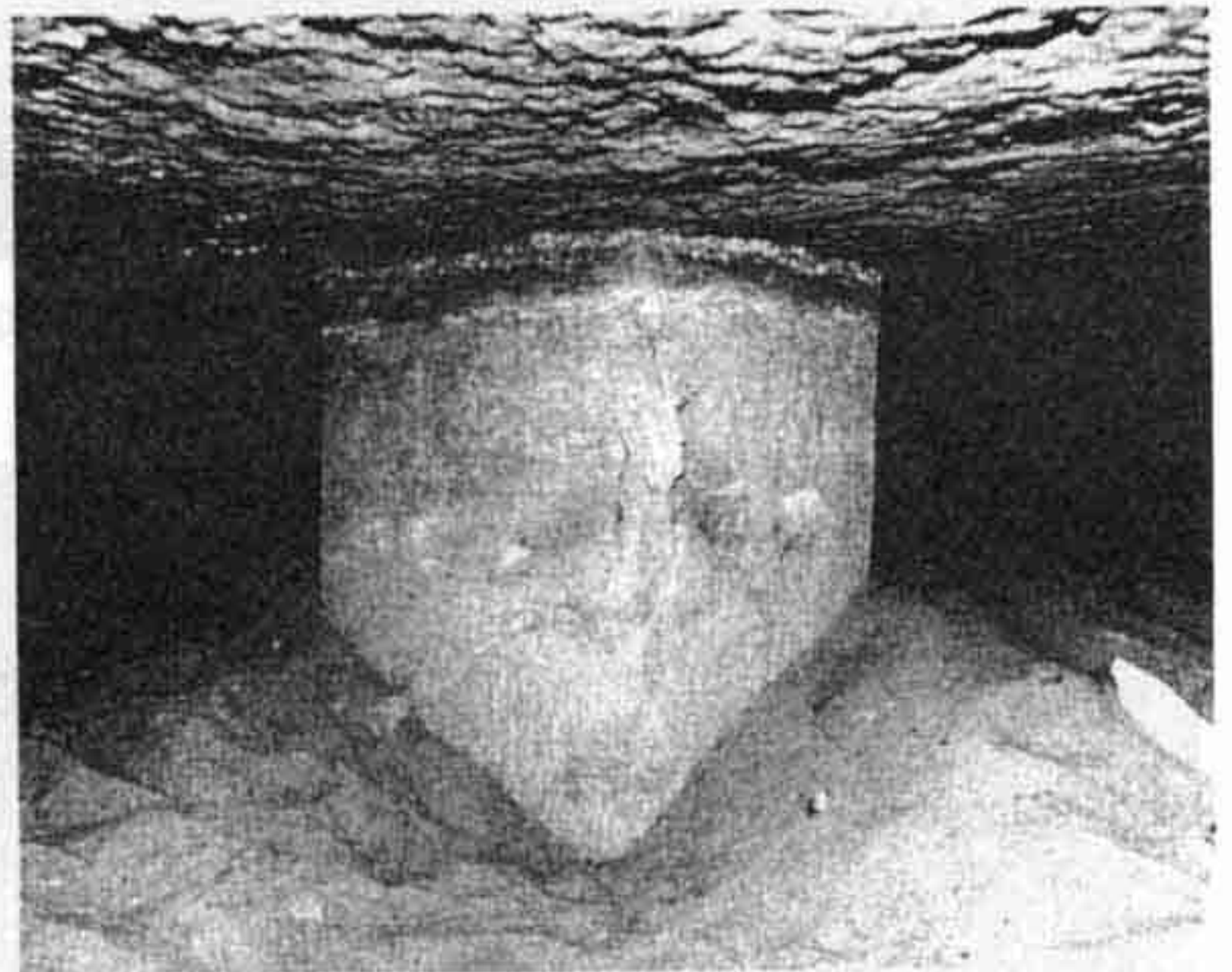

Pl. 5-4 The Central Pillar



Pl. 5-5 A Large Fragment of the Sarcophagus



Pl. 5-6 Burial Chamber from Inner Side

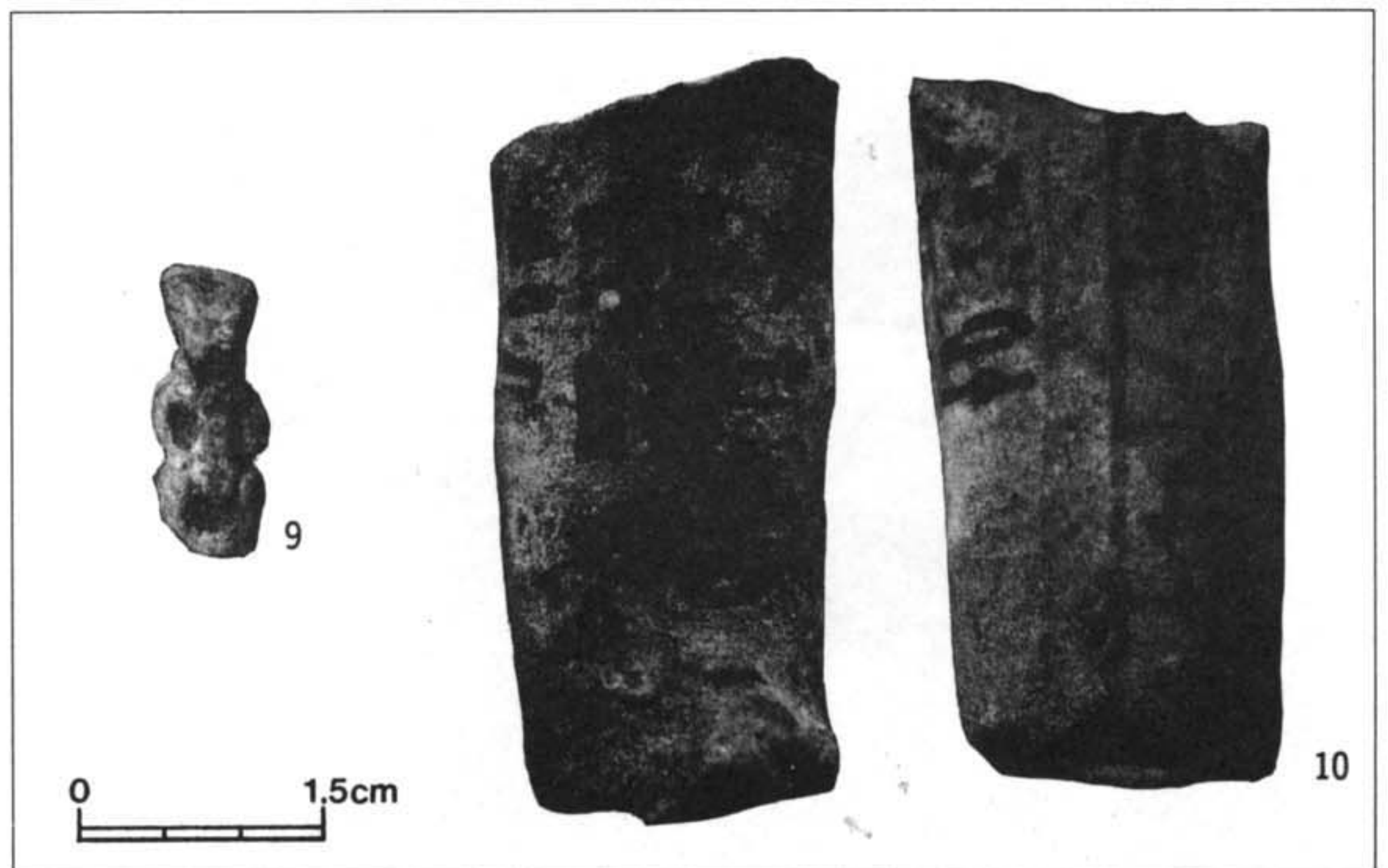
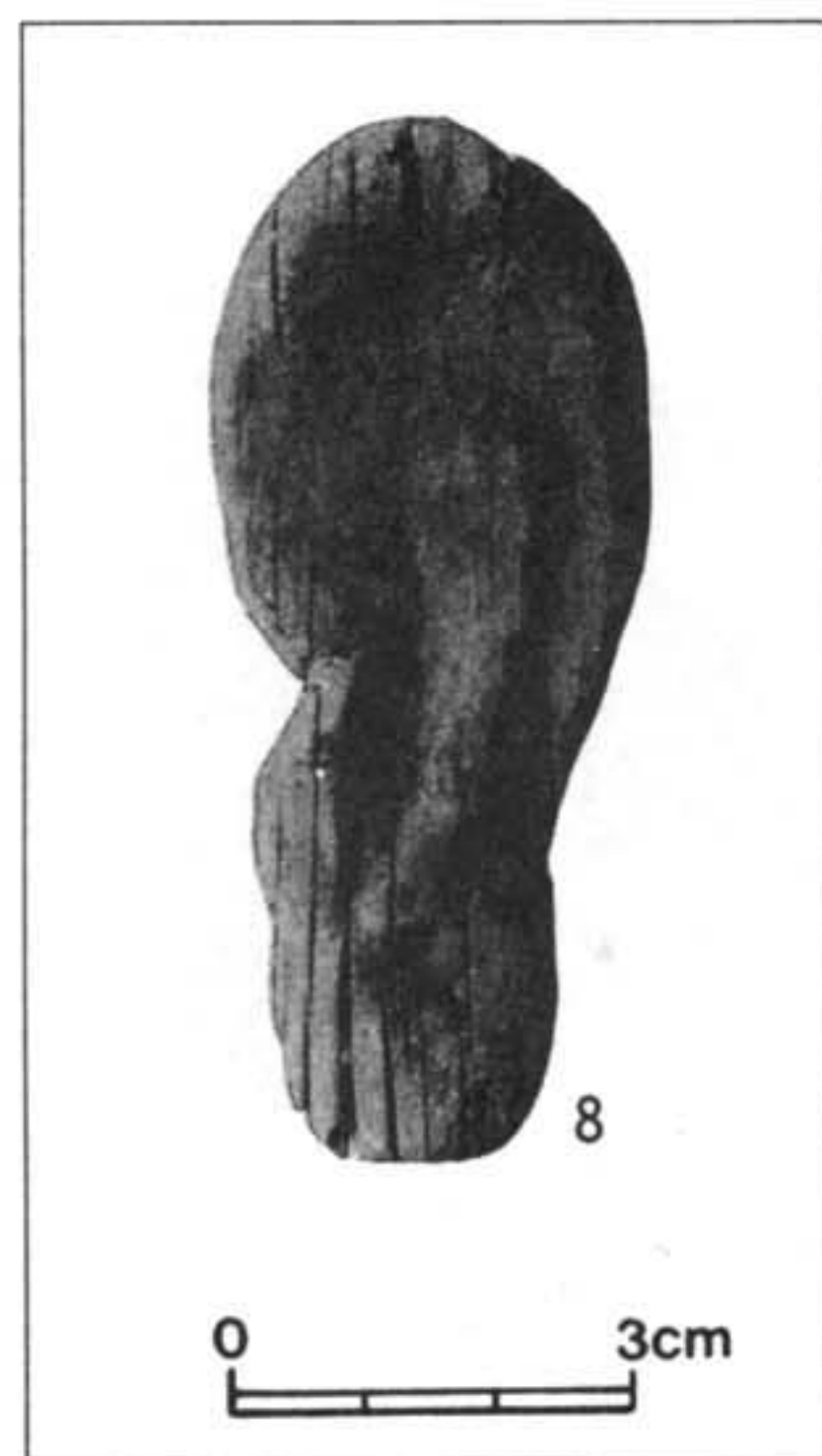
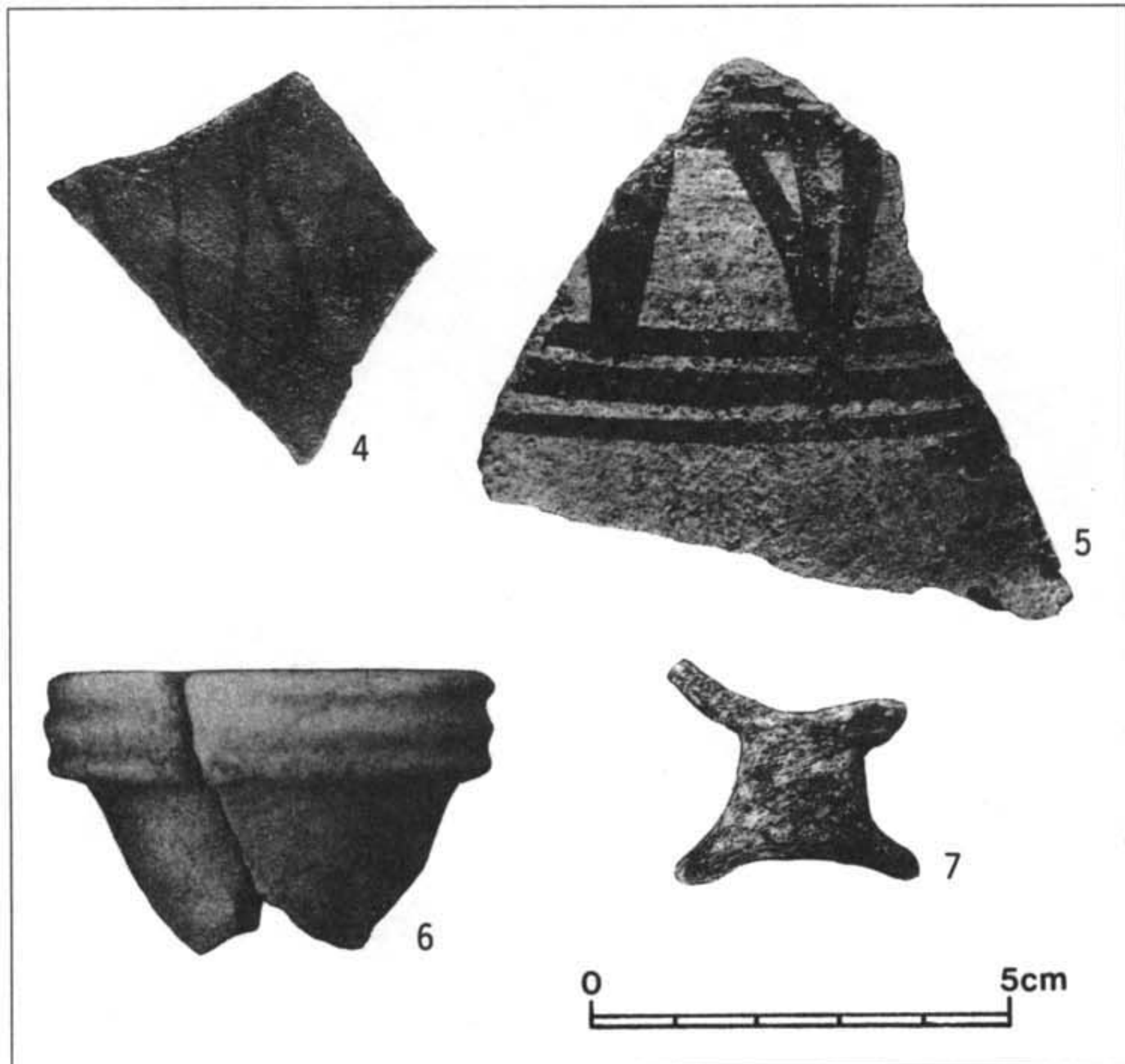
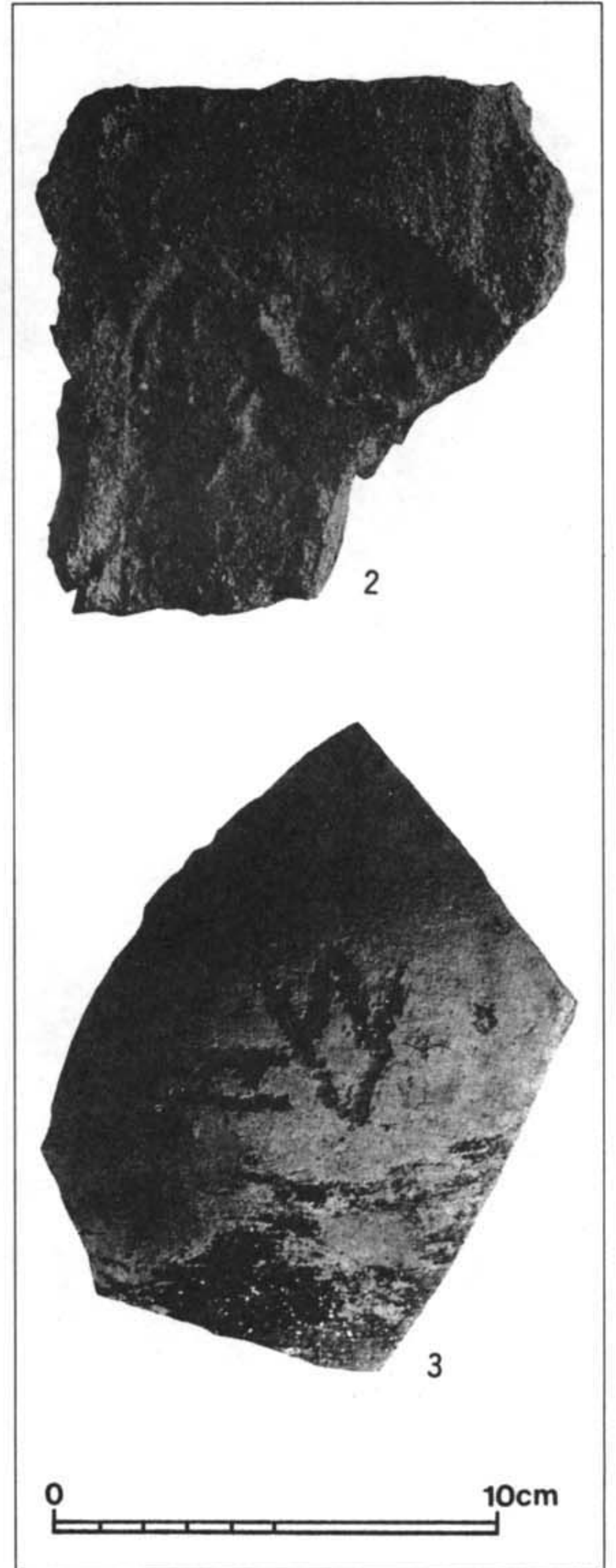
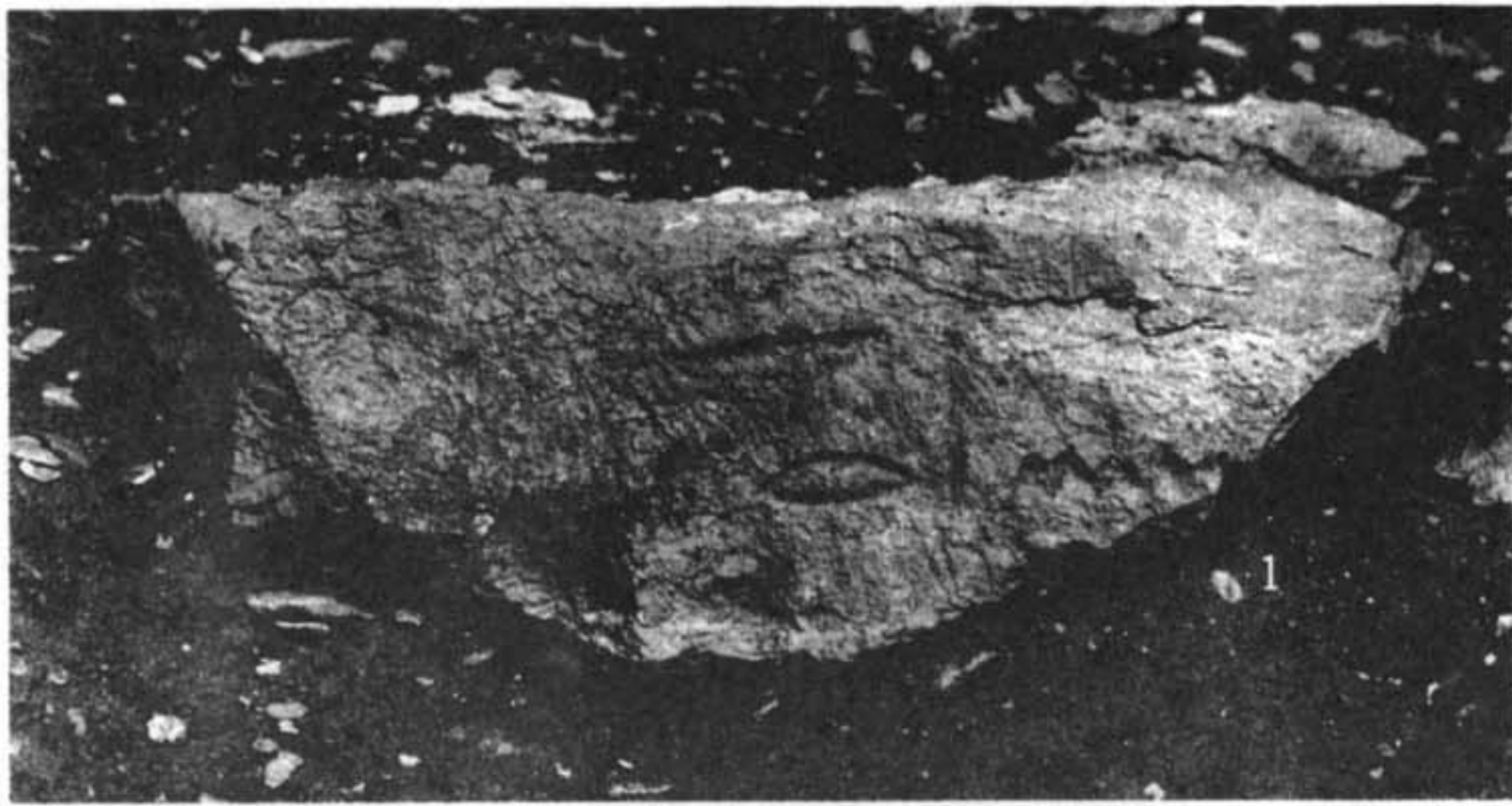

Pl. 6 Selected Finds



Pl. 7-1 Walls A1 and A2

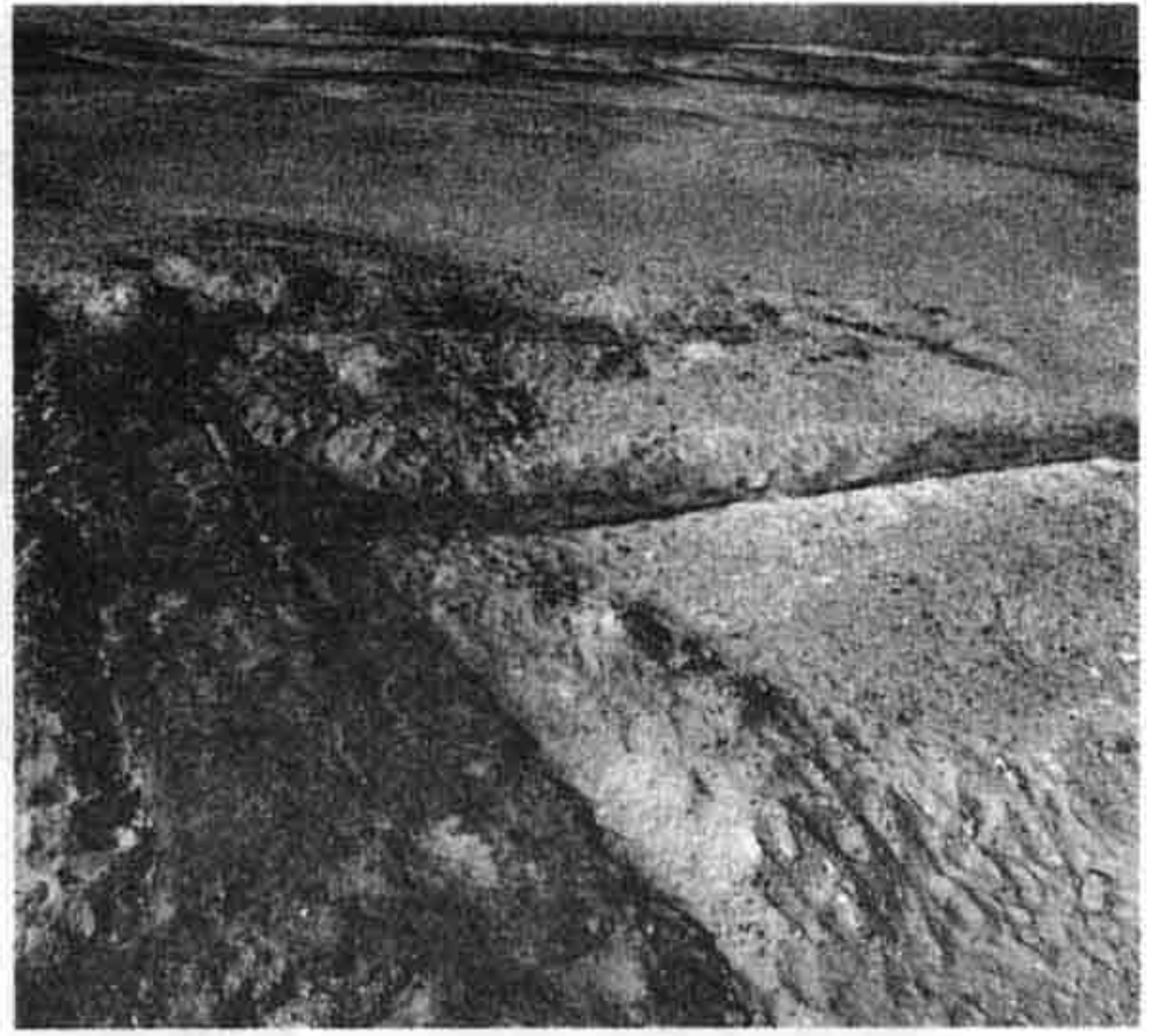

Pl. 7-2 Wall C

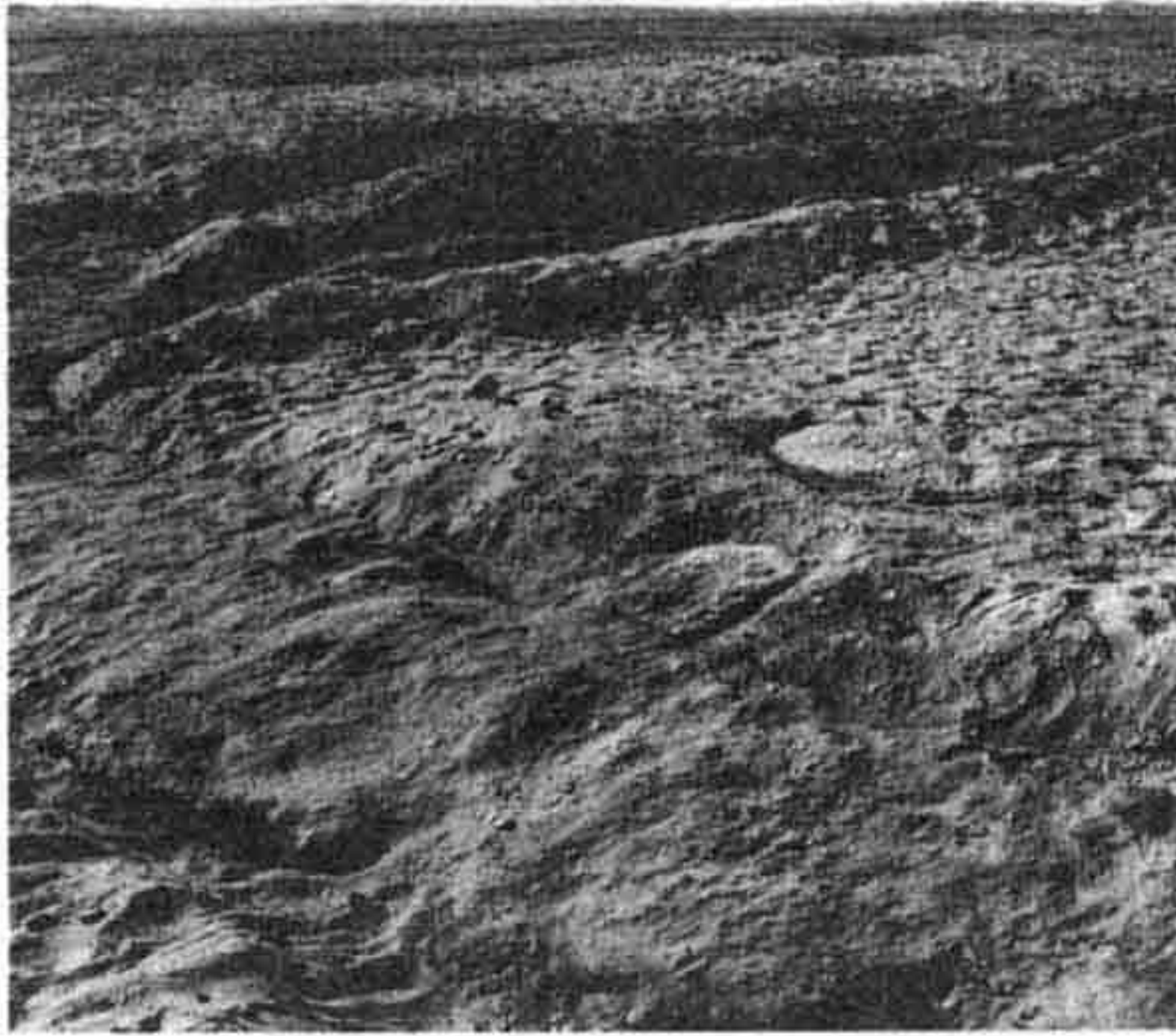

Pl. 7-3 Room E



Pl. 7-4 Walls B2, F3, and H2

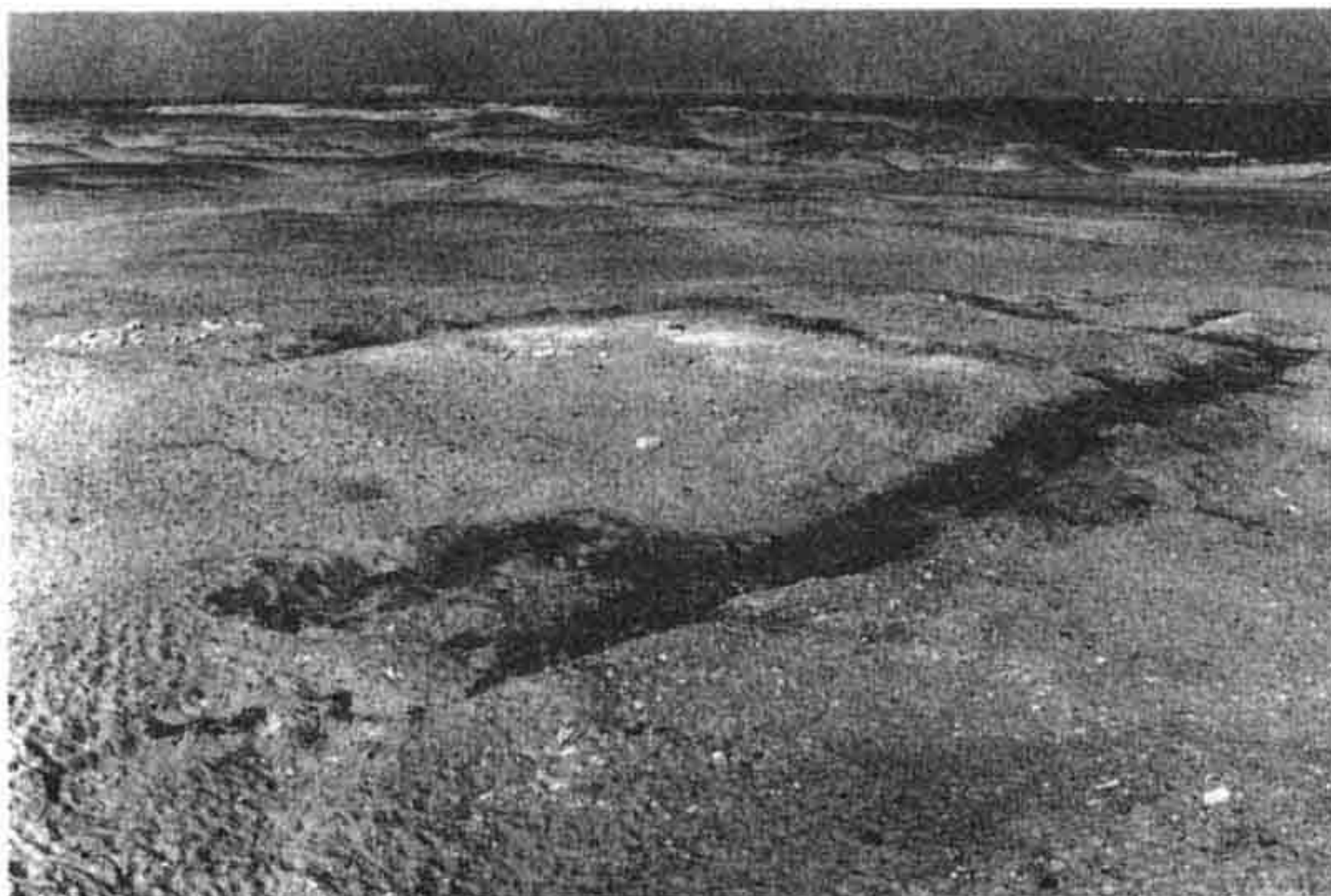

Pl. 7-5 The Mud-brick Building, from the south-west



Pl. 7-6 A Stamped Brick